

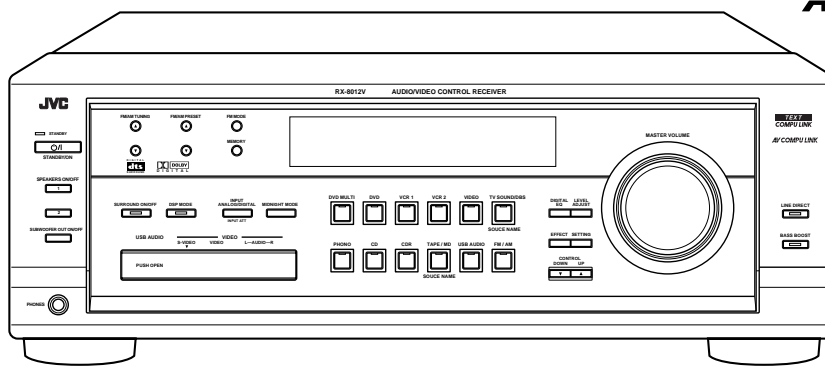

AUDIO/VIDEO CONTROL RECEIVER

RECEPTOR DE CONTROL DE AUDIO/VÍDEO
RECEPTOR DE COMANDO AUDIO/VÍDEO

RX-8012VSL

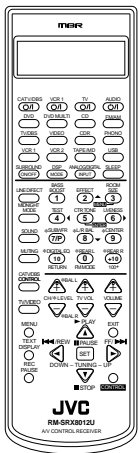

AV COMPU LINK

**TEXT
COMPU LINK**

DIGITAL
dts
SURROUND

DOLBY
DIGITAL

INSTRUCTIONS

MANUAL DE INSTRUCCIONES
INSTRUÇÕES

For Customer Use:

Enter below the Model No. and Serial No. which are located either on the rear, bottom or side of the cabinet. Retain this information for future reference.

Model No. _____

Serial No. _____

Warnings, Cautions and Others / Avisos, precauciones y otras notas / Advertências, precauções e outras notas

Caution — ⏻/! switch!

Disconnect the mains plug to shut the power off completely. The ⏻/! switch in any position does not disconnect the mains line. The power can be remote controlled.

Precaución — Interruptor ⏻/!

Desconectar el cable de alimentación para desactivar la alimentación totalmente. Cualquiera que sea la posición de ajuste del interruptor ⏻/!, la alimentación no es cortada completamente. La alimentación puede ser controlada remotamente.

Precaução — Interruptor ⏻/!

Desconectar o cabo de alimentação para desligar a alimentação por completo. Qualquer que seja a posição de ajuste do interruptor ⏻/!, a alimentação não é completamente cortada. A alimentação pode ser controlada remotamente.

CAUTION

To reduce the risk of electrical shocks, fire, etc.:

1. Do not remove screws, covers or cabinet.
2. Do not expose this appliance to rain or moisture.

ATENÇÃO

Para reduzir riscos de choques eléctricos, incêndio, etc.:

1. Não retire parafusos nem desmonte as tampas ou o gabinete.
2. Não exponha este aparelho à chuva nem à umidade.

CAUTION

- Do not block the ventilation openings or holes. (If the ventilation openings or holes are blocked by a newspaper or cloth, etc., the heat may not be able to get out.)
- Do not place any naked flame sources, such as lighted candles, on the apparatus.
- When discarding batteries, environmental problems must be considered and local rules or laws governing the disposal of these batteries must be followed strictly.
- Do not use this apparatus in a bathroom or places with water. Also do not place any containers filled with water or liquids (such as cosmetics or medicines, flower vases, potted plants, cups, etc.) on top of this apparatus.

AVISO

- Não obstrua as aberturas e orifícios de ventilação. (Se os orifícios ou aberturas de ventilação estiverem obstruídos por qualquer papel ou tecido, não haverá circulação do ar quente.)
- Não coloque nenhum objeto com chamas, como velas acesas, sobre o aparelho.
- Ao descartar as baterias, leve em consideração os problemas que possam ser causados ao meio ambiente e os regulamentos e leis locais e governamentais sobre recolhimento dessas baterias devem ser rigorosamente seguidos.
- Não utilize este aparelho em banheiros ou em locais com água. Além disso, não coloque nenhum recipiente com água ou qualquer tipo de líquido (como cosméticos ou remédios, vasos com flores, plantas, xícaras, etc.) sobre o aparelho.

PRECAUCIÓN

Para reducir riesgos de choques eléctricos, incendio, etc.:

1. No extraiga los tornillos, los cubiertas ni la caja.
2. No exponga este aparato a la lluvia o a la humedad.

PRECAUCION

- No obstruya las rendijas o los orificios de ventilación. (Si las rendijas o los orificios de ventilación quedan tapados con un periódico, un trozo de tela, etc., no se podrá disipar el calor).
- No ponga sobre el aparato ninguna llama al descubierto, como velas encendidas.
- Cuando tenga que descartar las pilas, tenga en cuenta los problemas ambientales y observe estrictamente los reglamentos o las leyes locales sobre disposición de las pilas.
- No utilice este aparato en el cuarto de baño o en lugares donde hay agua. Tampoco coloque ningún recipiente que contenga agua u otros líquidos (frascos de cosméticos o medicinas, floreros, macetas, vasos, etc.) encima de este aparato.

Caution: Proper Ventilation

To avoid risk of electric shock and fire and to protect from damage.

Locate the apparatus as follows:

- Front: No obstructions open spacing.
 - Sides: No obstructions in 10 cm from the sides.
 - Top: No obstructions in 10 cm from the top.
 - Back: No obstructions in 15 cm from the back.
 - Bottom: No obstructions, place on the level surface.
- In addition, maintain the best possible air circulation as illustrated.

Precaución: Ventilación Adecuada

Para evitar el riesgo de choque eléctrico e incendio y para proteger el aparato contra daños.

Ubique el aparato de la siguiente manera:

- Frente: Espacio abierto sin obstrucciones
- Lados: 10 cm sin obstrucciones a los lados
- Parte superior: 10 cm sin obstrucciones en la parte superior
- Parte trasera: 15 cm sin obstrucciones en la parte trasera
- Fondo: Sin obstrucciones, colóquelo sobre una superficie nivelada

Además, mantenga la mejor circulación de aire posible como se ilustra.

Precaução: ventilação apropriada

Para prevenir o risco de choque elétrico ou incêndio e para proteger o aparelho contra danos.

Localize-o da seguinte maneira:

- Frente: Espaço aberto, sem obstruções
- Lados: Espaço de 10 cm sem obstruções nos lados
- Topo: Espaço de 10 cm sem obstruções acima
- Atrás: Espaço de 15 cm sem obstruções atrás
- Parte inferior: Sem obstruções. Coloque o aparelho em superfície nivelada.

Mantenha, além disso, a maior circulação de ar possível, como indica a ilustração.

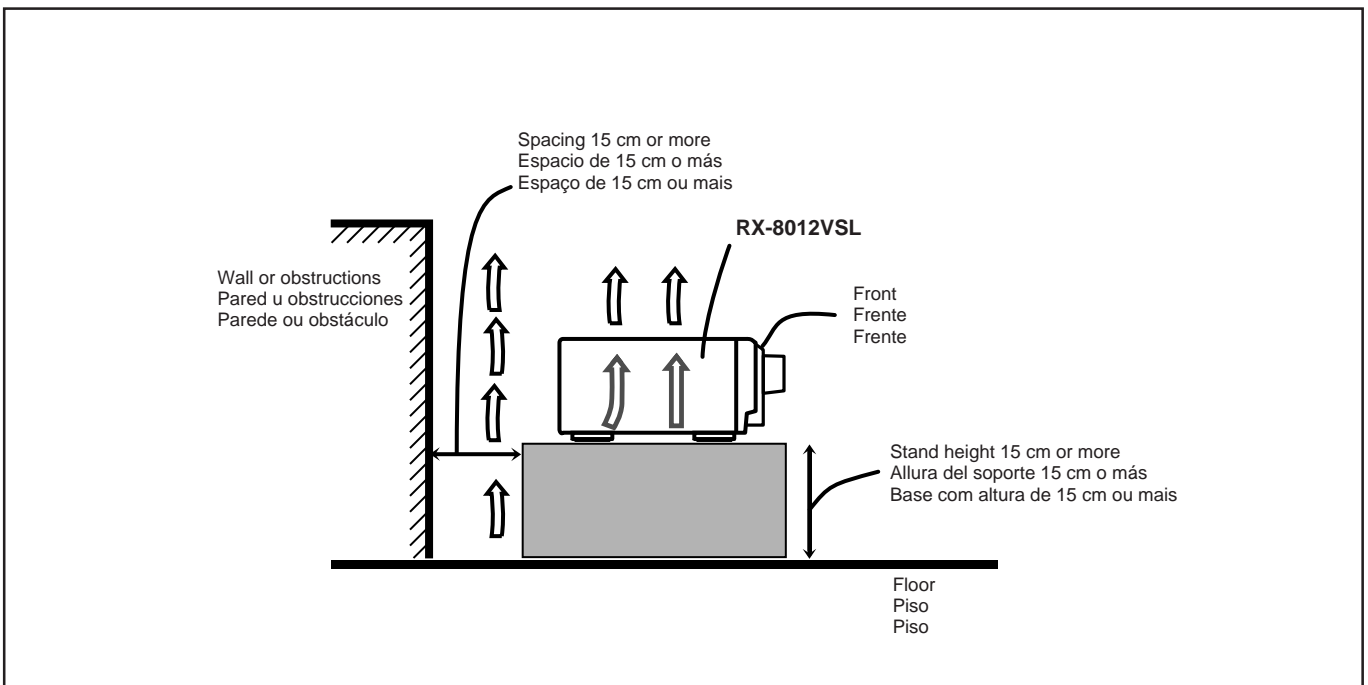
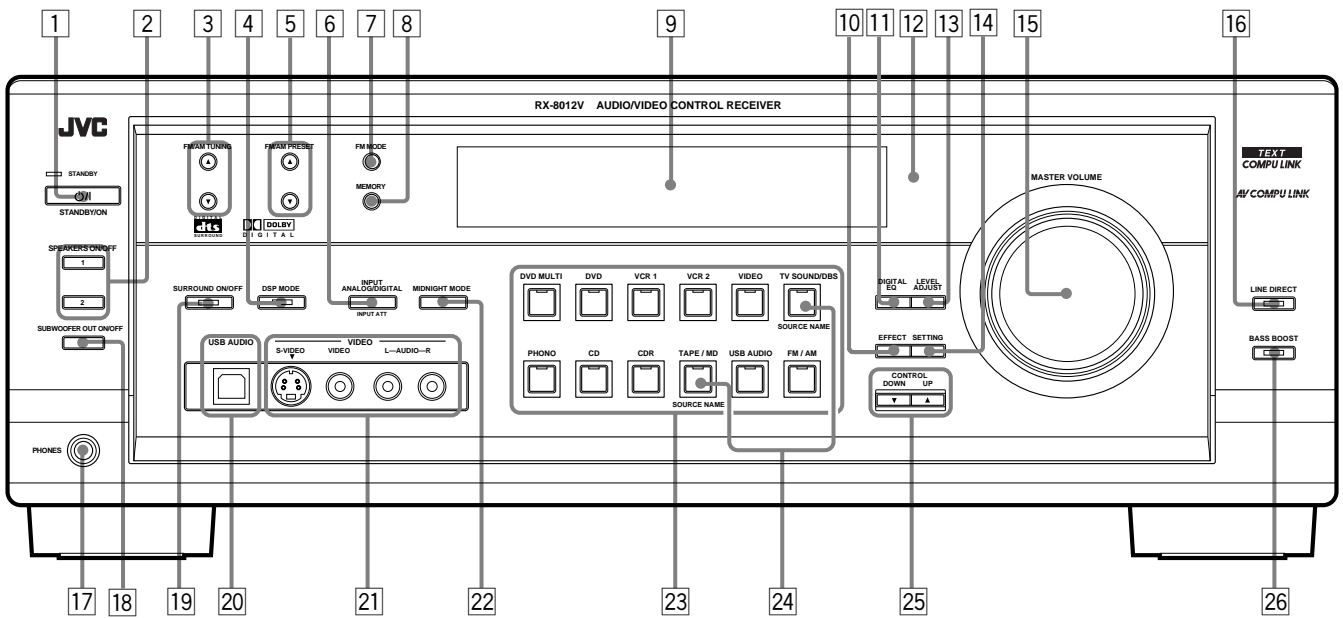

Table of Contents

Parts Identification	2	Creating a Surround Field in Your Room	24
Getting Started	3	■ Surround modes	24
Before Installation	3	■ DSP modes	24
Checking the Supplied Accessories	3	Reproducing the Sound Field	25
Setting the Voltage Selector Switch	3	Available DSP Modes According to the Speaker Arrangement ..	26
Connecting the FM and AM Antennas	3	Adjusting the Surround Modes	27
Connecting the Speakers	4	Adjusting the DAP Modes	28
Connecting Audio/Video Components	5	Adjusting the Surround Modes with the DAP Modes	30
■ Analog Connections	5	Adjusting the 5 CH/4 CH Stereo Mode	32
■ Digital Connections	8	Adjusting the 3D-PHONIC Modes	33
■ USB Connection	9	Using the DVD MULTI Playback Mode	35
Connecting the Power Cord	10	Activating the DVD MULTI Playback Mode	35
Putting Batteries in the Remote Control	10	Using the On-Screen Menus	36
Basic Operations	11	■ Showing the MENU on the TV Screen	36
Turning the Power On and Off (Standby)	11	■ Activating the Surround Modes	36
Selecting the Source to Play	11	■ Activating the DSP Modes	36
Adjusting the Volume	12	■ Selecting the Analog or Digital Input Mode	36
Selecting the Front Speakers	13	■ Adjusting the Equalization Pattern	37
Muting the Sound	13	■ Adjusting the Surround and DSP Modes	37
Listening at Night — Midnight Mode	13	■ Adjusting the DVD MULTI Playback Mode	38
Activating the Subwoofer Sound	14	■ Listening at Night — Midnight Mode	38
Reinforcing the Bass	14	■ Attenuating the Input Signal	38
Attenuating the Input Signal	14	■ Selecting the Line Direct Function	39
Selecting the Line Direct Function	14	■ Selecting the Bass Boost Function	39
Adjusting the Equalization Patterns	15	■ Activating the Subwoofer Sound	39
Using the Sleep Timer	15	■ Operating the Tuner	39
Recording a Source	15	■ Storing the Preset Stations	39
Basic Settings	16	■ Setting the Basic Setting Items	40
Adjusting the Front Speaker Output Balance	16	COMPU LINK Remote Control System	41
Changing the Source Name	16	TEXT COMPU LINK Remote Control System ..	42
Selecting the Video Input Terminal	16	■ Showing the Disc Information on the TV Screen	43
Setting the Subwoofer Information	17	■ Searching for a Disc (Only for the CD player)	44
Adjusting the Subwoofer Output Level	17	■ Entering the Disc Information	45
Setting the Speakers for a Surround Field	17	AV COMPU LINK Remote Control System	47
Digital Input (DIGITAL IN) Terminal Setting	19	Operating JVC's Audio/Video Components ...	49
Selecting the Analog or Digital Input Mode	20	Operating Audio Components	49
Showing the Text Information on the Display	21	Operating Video Components	51
Basic Setting and Adjustment — Auto Memory	21	Operating Other Manufacturers' Video	
Receiving Radio Broadcasts	22	Equipment	52
Setting the AM Tuner Interval Spacing	22	Troubleshooting	55
Tuning in Stations Manually	22	Specifications	57
Using Preset Tuning	22		
Selecting the FM Reception Mode	23		

Parts Identification

Become familiar with the buttons and controls on the receiver before use.
Refer to the pages in parentheses for details.



Remote Control

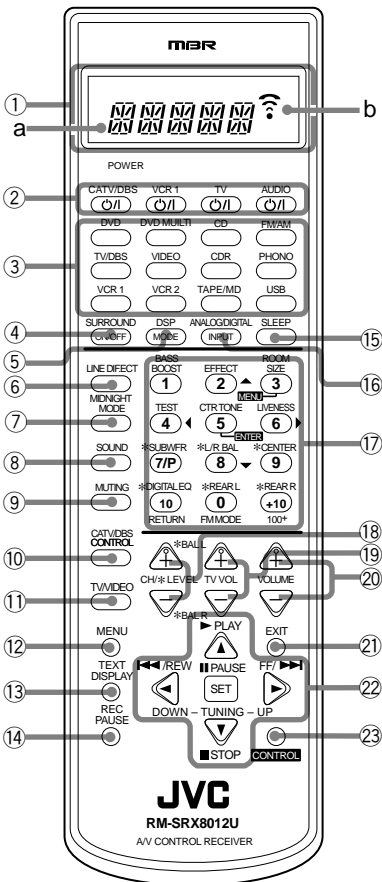

- ① Display window (11)
 - a. Remote control operation mode indicator
 - b. Signal transmission indicator
Lights up when transmitting the remote control signal.
- ② **⏻/⏻** buttons (11, 51 – 54)
CATV/DBS, VCR 1, TV, AUDIO
- ③ Source selecting buttons (11)
DVD, DVD MULTI, CD, FM/AM, TV/DBS, VIDEO, CDR, PHONO, VCR 1, VCR 2, TAPE/MD, USB
- ④ SURROUND ON/OFF button (26, 27, 30)
- ⑤ DSP MODE button (26, 29 – 33)
- ⑥ LINE DIRECT button (14)
- ⑦ MIDNIGHT MODE button (13)
- ⑧ SOUND button (14 – 17, 27 – 35, 49)
- ⑨ MUTING button (13)
- ⑩ CATV/DBS CONTROL button (53)
- ⑪ TV/VIDEO button (51, 52)
- ⑫ MENU button (36 – 40)
- ⑬ TEXT DISPLAY button (43 – 46)
- ⑭ REC PAUSE button (50, 51, 53)
- ⑮ SLEEP button (15)
- ⑯ ANALOG/DIGITAL INPUT button (20)
- ⑰ • 10 keys for selecting preset channels (23)
• 10 keys for adjusting sound (14 – 17, 27 – 35, 49)
• 10 keys for operating audio/video components (49 – 54)
- ⑱ • LEVEL +/- buttons* (15, 17, 27 – 35)
• BAL L and BAL R buttons* (16)
• CH +/- buttons (51 – 53)
- ⑲ TV VOL +/- buttons (51, 52)
- ⑳ VOLUME +/- buttons (12)
- ㉑ EXIT button (36 – 40, 43 – 45)
- ㉒ • TUNING UP **▶**/DOWN **◀** buttons (22, 49)
• On screen operation buttons (36 – 40, 43 – 46)
• Operating buttons for audio/video components (49 – 54)
- ㉓ CONTROL button (50, 51)

Front Panel

- ① STANDBY/ON **⏻/⏻** button and STANDBY lamp (11, 22)
- ② • SPEAKERS ON/OFF 1 button (13)
• SPEAKERS ON/OFF 2 button (13)
- ③ FM/AM TUNING **▲**/**▼** buttons (22)
- ④ DSP MODE button and lamp (26, 28 – 33)
- ⑤ FM/AM PRESET **▲**/**▼** buttons (22, 23)
- ⑥ • INPUT ANALOG/DIGITAL button (20)
• INPUT ATT button (14)
- ⑦ FM MODE button (23)
- ⑧ MEMORY button (22)
- ⑨ Display (11)
- ⑩ EFFECT button (28 – 33)
- ⑪ DIGITAL EQ button (15)
- ⑫ Remote sensor (10)
- ⑬ LEVEL ADJUST button (16, 17, 28 – 35)
- ⑭ SETTING button (16 – 19, 21)
- ⑮ MASTER VOLUME control (12)
- ⑯ LINE DIRECT button and lamp (14)
- ⑰ PHONES jack (13)
- ⑱ SUBWOOFER OUT ON/OFF button (14)
- ⑲ SURROUND ON/OFF button and lamp (26, 28, 31)
- ⑳ USB AUDIO terminal (9)
- ㉑ VIDEO input terminals (7)
- ㉒ MIDNIGHT MODE button (13)
- ㉓ Source selecting buttons and lamps (11)
DVD MULTI, DVD, VCR 1, VCR 2, VIDEO, TV SOUND/DBS, PHONO, CD, CDR, TAPE/MD, USB AUDIO, FM/AM
- ㉔ SOURCE NAME buttons (16)
- ㉕ CONTROL UP **▲**/DOWN **▼** buttons
- ㉖ BASS BOOST button and lamp (14)

* These buttons function only after pressing 10 keys on the remote control which are marked with an asterisk (*).

Getting Started

This section explains how to connect audio/video components and speakers to the receiver, and how to connect the power supply.

Before Installation

General

- Be sure your hands are dry.
- Turn the power off to all components.
- Read the manuals supplied with the components you are going to connect.

Locations

- Install the receiver in a location that is level and protected from moisture.
- The temperature around the receiver must be between -5°C and 35°C (23°F and 95°F).
- Make sure there is good ventilation around the receiver. Poor ventilation could cause overheating and damage the receiver.

Handling the receiver

- Do not insert any metal object into the receiver.
- Do not disassemble the receiver or remove screws, covers, or cabinet.
- Do not expose the receiver to rain or moisture.

Checking the Supplied Accessories

Check to be sure you have all of the following items, which are supplied with the receiver.

The number in the parentheses indicates quantity of the pieces supplied.

- Remote Control (1)
- Batteries (2)
- AM Loop Antenna (1)
- FM Antenna (1)
- AC Plug Adaptor (1)

If anything is missing, contact your dealer immediately.

Setting the Voltage Selector Switch

Before connections, always do the following first if necessary.

Set the correct voltage for your area with the voltage selector switch on the rear panel. Rotate the voltage selector using a screw driver, so the voltage number the voltage mark is set at is the same as the voltage where you are plugging in the receiver.

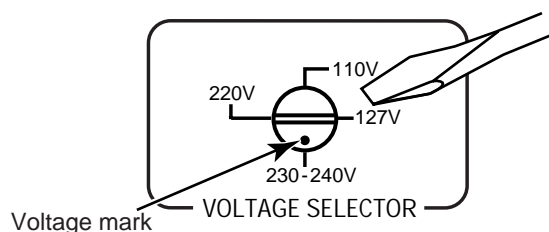

Connecting the FM and AM Antennas

FM Antenna Connections

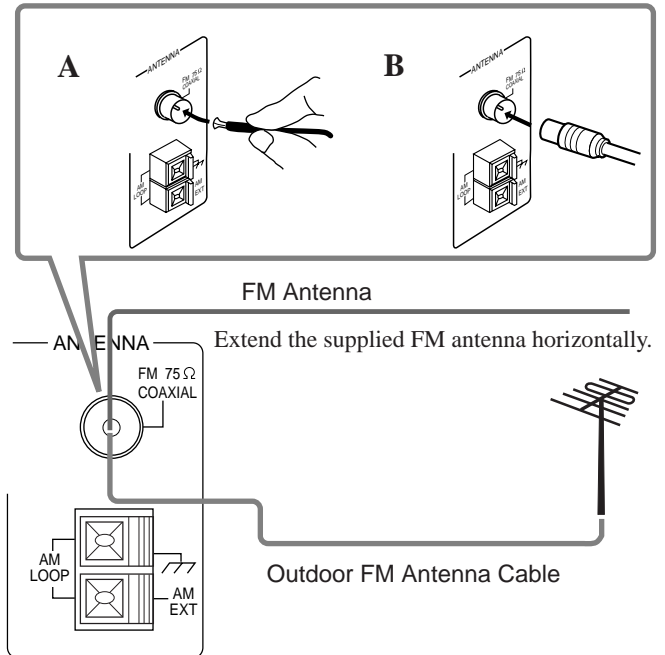

A. Using the Supplied FM Antenna

The FM antenna provided can be connected to the FM 75 Ω COAXIAL terminal as temporary measure.

B. Using the Standard Type Connector (Not Supplied)

A standard type connector should be connected to the FM 75 Ω COAXIAL terminal.

Note:

If reception is poor, connect the outdoor antenna. Before attaching a 75 Ω coaxial cable (the kind with a round wire going to an outdoor antenna), disconnect the supplied FM antenna.

AM Antenna Connections

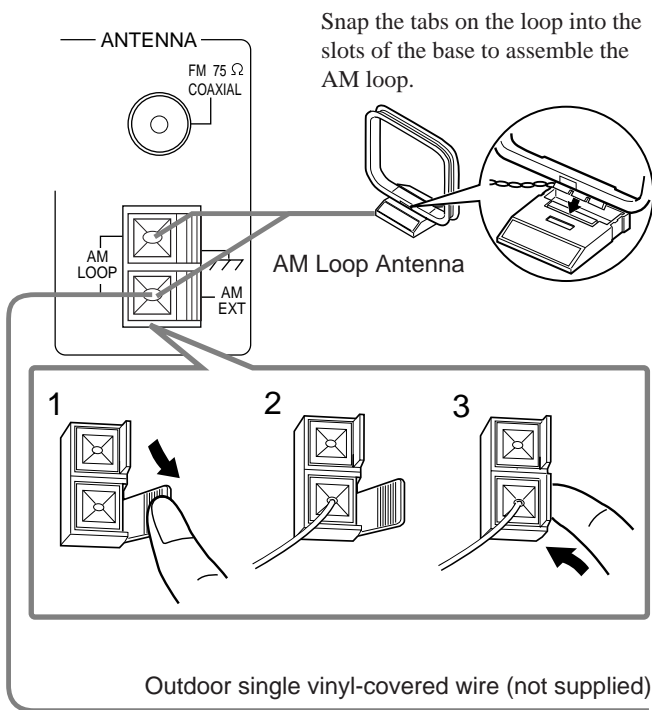

Turn the loop until you have the best reception.

Notes:

- If the AM loop antenna wire is covered with vinyl, remove the vinyl by twisting it as shown in the diagram.
- Make sure the antenna conductors do not touch any other terminals, connecting cords and power cord. This could cause poor reception.
- If reception is poor, connect an outdoor single vinyl-covered wire to the AM EXT terminal. (Keep the AM loop antenna connected.)



Connecting the Speakers

You can connect the following speakers:

- Two pairs of front speakers to produce normal stereo sound.
- One pair of rear speakers to enjoy the surround effect.
- One center speaker to produce more effective surround effect (to emphasize human voices).
- One subwoofer to enhance the bass.

IMPORTANT:

After connecting the speakers listed above, set the speaker setting information properly to obtain the best possible Surround and DSP effect. For details, see page 17.

For each speaker (except for a subwoofer), connect the (+) and (-) terminals on the rear panel to the (+) and (-) terminals marked on the speakers. For connecting a subwoofer, see page 5.

CAUTION:

Use speakers with the SPEAKER IMPEDANCE indicated by the speaker terminals.

Basic connecting procedure

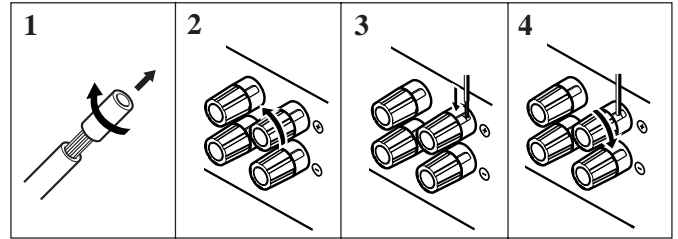

- 1 Cut, twist and remove the insulation at the end of each speaker signal cable (not supplied).
- 2 Turn the knob counterclockwise.
- 3 Insert the speaker signal cable.
- 4 Turn the knob clockwise.

Connecting the front speakers

You can connect two pairs of front speakers (one pair to the FRONT SPEAKERS ① terminals, and another pair to the FRONT SPEAKERS ② terminals).

Right speaker — FRONT SPEAKERS ① — Left speaker

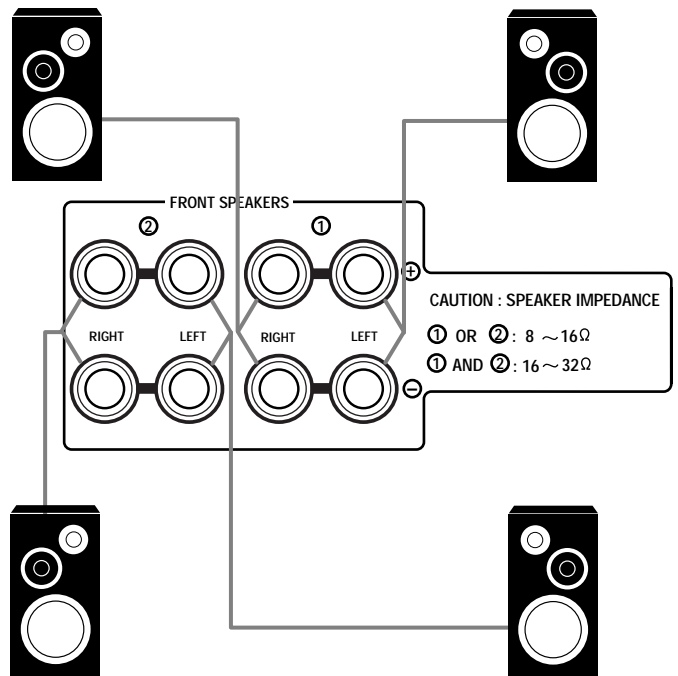

Right speaker — FRONT SPEAKERS ② — Left speaker

About the speaker impedance

The required speaker impedance of the front speakers does differ depending on whether both the FRONT SPEAKERS ① and FRONT SPEAKERS ② terminals are used or only one of them is used.

CASE 1 When you connect only one pair of front speakers

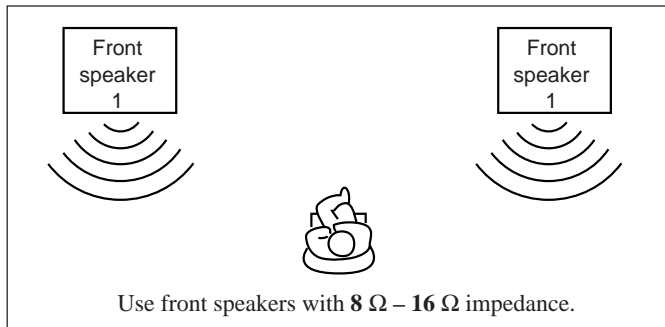

CASE 2 When you connect two pairs of front speakers

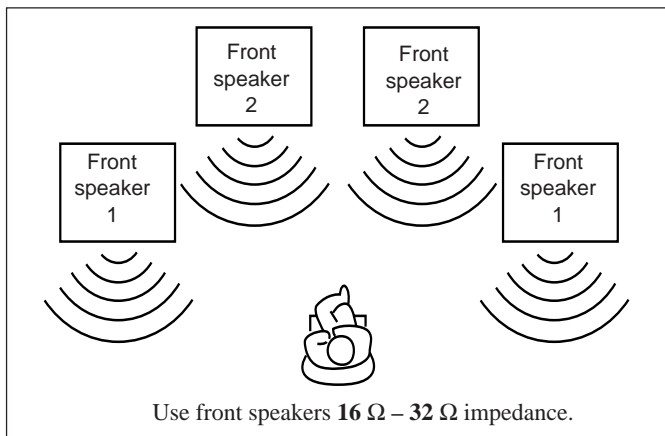

Connecting the rear and center speakers

Connect rear speakers to the REAR SPEAKERS terminals and a center speaker to the CENTER SPEAKER terminals.

Center speaker

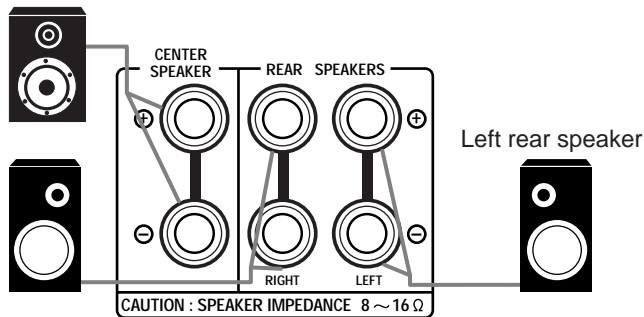

Right rear speaker

Connecting the subwoofer speaker

You can enhance the bass by connecting a subwoofer. Connect the input jack of a powered subwoofer to the SUBWOOFER OUT jack on the rear panel, using a cable with RCA pin plugs (not supplied).



Powered subwoofer

Connecting Audio/Video Components

You can connect the following audio/video components to this receiver. Refer also to the manuals supplied with your components.

Audio Components	Video Components
• Turntable	• DVD player*
• CD player*	• TV*
• Cassette deck or MD recorder*	• DBS tuner*
• CD recorder*	• VCR(s)
• Personal computer (PC)	• Video camera

* You can connect these components using the methods described in "Analog connections" (below), or in "Digital connections" (see page 8).

Analog Connections

Audio component connections

Use the cables with RCA pin plugs (not supplied). Connect the white plug to the audio left jack, and the red plug to the audio right jack.

CAUTION:

If you connect a sound-enhancing device such as a graphic equalizer between the source components and this receiver, the sound output through this receiver may be distorted.

Turntable

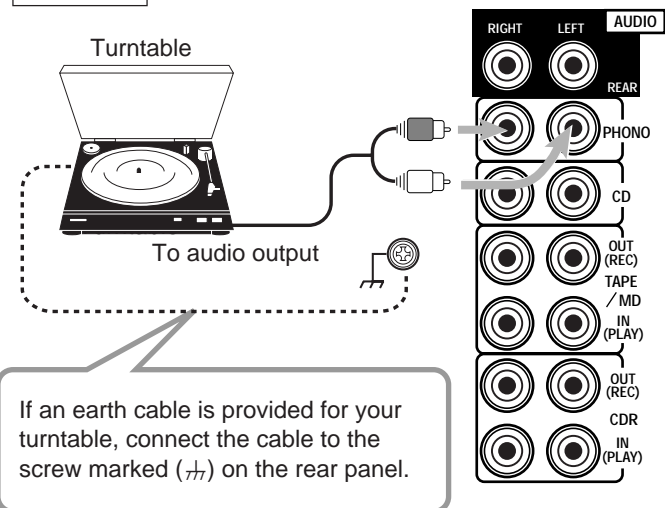

Ex.: This connection is for the turntable with an MM (moving-magnet) type cartridge.

Note:

Any turntables incorporating a small-output cartridge such as an MC (moving-coil) type must be connected to this receiver through a commercial head amplifier or step-up transformer. Direct connection may result in insufficient volume.

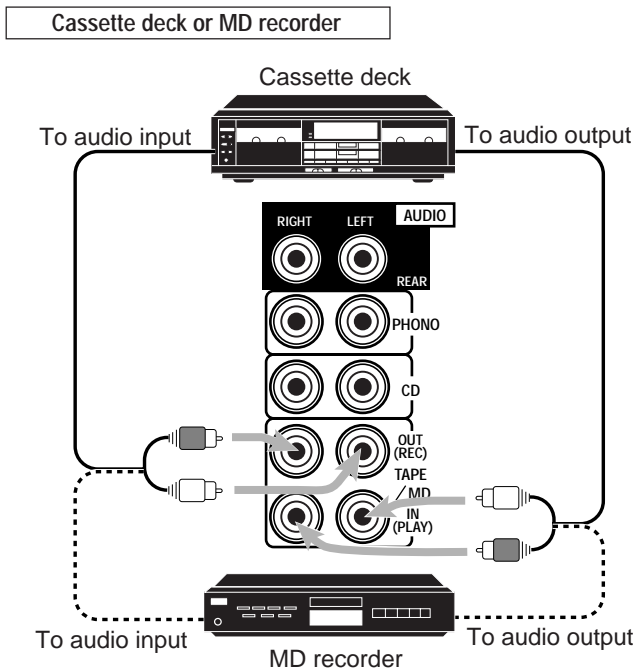
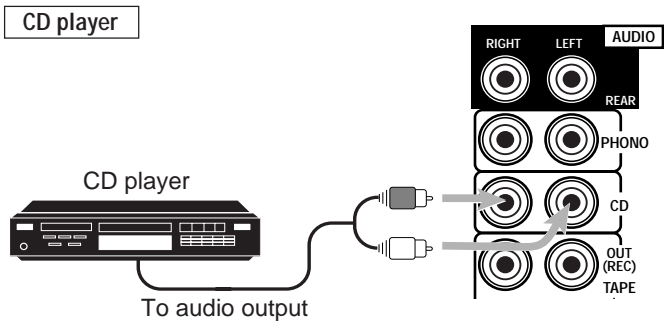
**Note:**

You can connect either a cassette deck or an MD recorder to the TAPE/MD jacks. When connecting an MD recorder to the TAPE/MD jacks, change the source name, which will be shown on the display when selected as the source, to "MD." See page 16 for details.

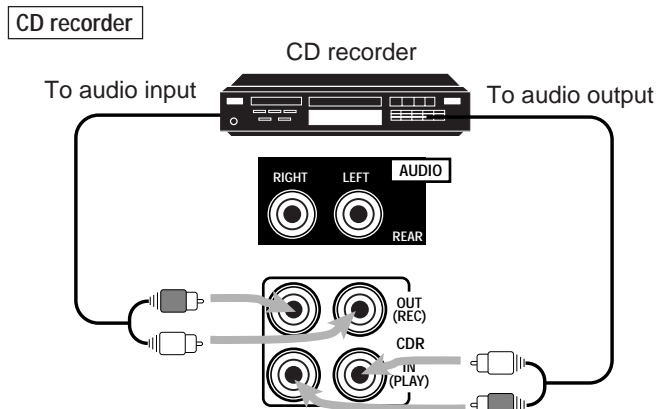

If your audio components have a COMPU LINK or TEXT COMPU LINK jack

- See also page 41 for detailed information about the connection and the COMPU LINK remote control system.
- See also page 42 for detailed information about the connection and the TEXT COMPU LINK remote control system.

Video component connections

Use the cables with RCA pin plugs (not supplied).

Connect the white plug to the audio left jack, the red plug to the audio right jack, and the yellow plug to the video jack.

- If your video components have S-video (Y/C-separation) and/or component video (Y, P_B/C_B, P_R/C_R) terminals, connect them using an S-video cable (not supplied) and/or component video cable (not supplied). By using these terminals, you can get a better picture quality in the order — Component video > S-video > Composite video.

IMPORTANT:

This receiver is equipped with the following video terminals — composite video, S-video and component video terminals. You can use any of the three to connect a video component.

However, **remember that the video signals from one type of these input terminals are output only through the video output terminals of the same type.**

Therefore, if a recording video component and a playing video component are connected to the receiver through the different video terminals, you cannot record the picture from the playing component on the recording component. In addition, if the TV and a playing video component are connected to the receiver through the different video terminals, you cannot view the playback picture from the playing component on the TV.

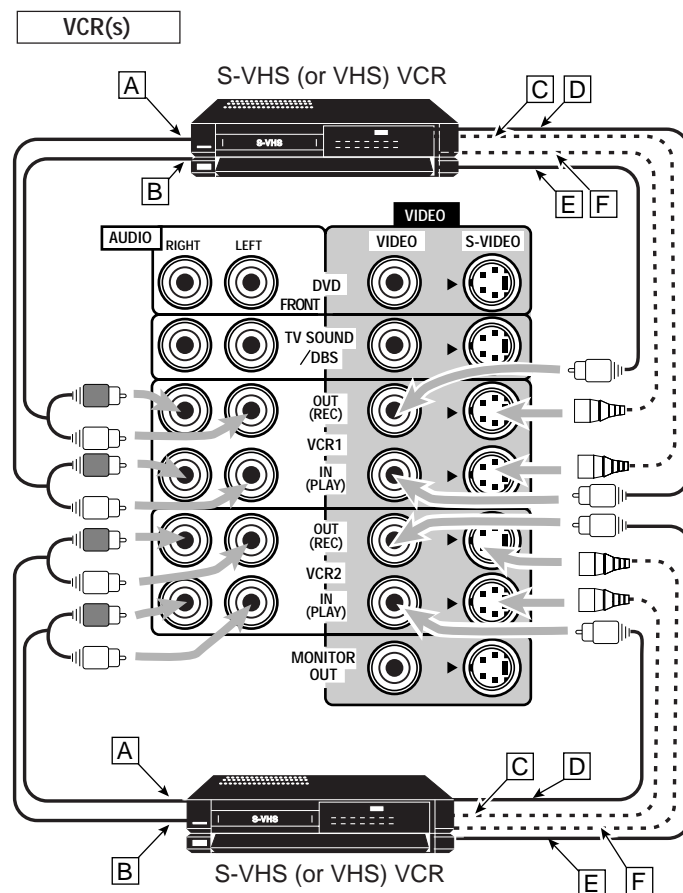

- A To left/right channel audio output
- B To left/right channel audio input
- C To S-video output
- D To composite video output
- E To composite video input
- F To S-video input

TV and/or DBS tuner

When connecting the TV to the AUDIO jacks (TV SOUND/DBS), DO NOT connect the TV's video output to these video input terminals.

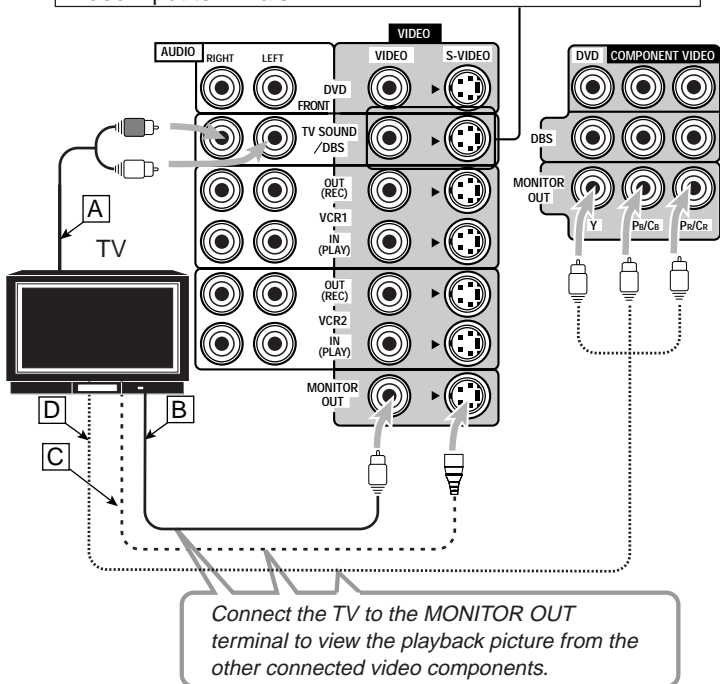

- A To audio output
- B To composite video input
- C To S-video input
- D To component video input

Video camera

The VIDEO input terminals on the front panel are convenient when connecting and disconnecting the equipment frequently.

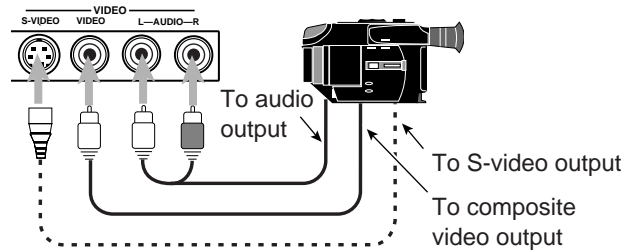

DVD player

When you connect the DVD player with stereo output jacks:

- A To front left/right channel audio output (or to audio mixed output if necessary)
- B To composite video output
- C To S-video output
- D To component video output

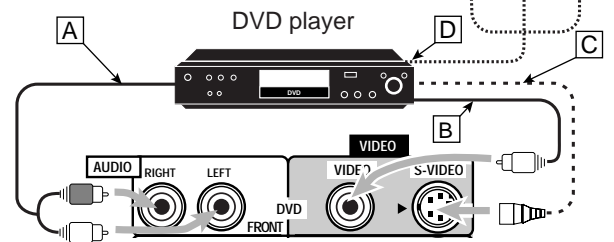

When you connect the DVD player with its analog discrete output (5.1 CH reproduction) jacks:

- A To subwoofer output
- B To center channel audio output
- C To rear left/right channel audio output
- D To front left/right channel audio output
- E To composite video output
- F To S-video output
- G To component video output

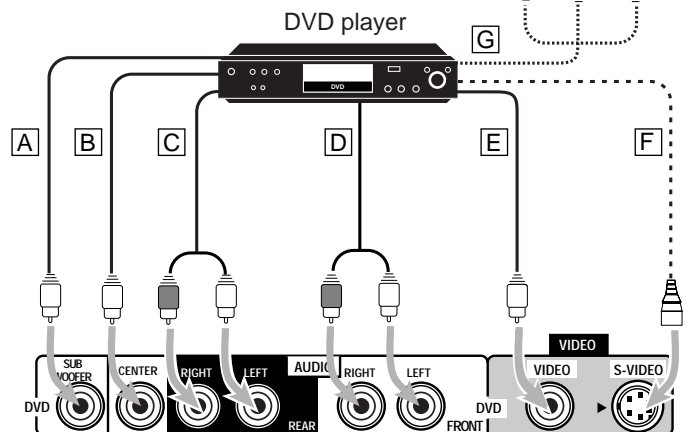

Note:

When operating the DVD player by using the AV COMPU LINK remote control system, change the video input terminal setting correctly. See pages 16 and 47 for details.

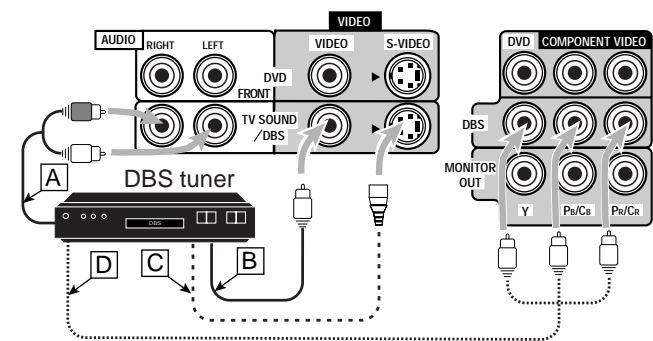

- A To audio output
- B To composite video output
- C To S-video output
- D To component video output

Notes:

- When connecting the DBS tuner to the TV SOUND/DBS jacks, change the source name, which will be shown on the display when selected as the source, to "DBS." See page 16 for details.
- When operating the DBS tuner by using the AV COMPU LINK remote control system, change the video input terminal setting correctly. See pages 16 and 47 for details.

Digital Connections

This receiver is equipped with four DIGITAL IN terminals — one digital coaxial terminal and three digital optical terminals, and one DIGITAL OUT terminal.

IMPORTANT:

- When connecting the DVD player, digital TV broadcast tuner or DBS tuner using the digital terminals, you also need to connect it to the video terminal on the rear. Without connecting it to the video terminal, you can view no playback picture.
- After connecting the components using the DIGITAL IN terminals, set the following correctly if necessary.
 - Set the digital input (DIGITAL IN) terminal setting correctly. For details, see “Digital Input (DIGITAL IN) Terminal Setting” on page 19.
 - Select the digital input mode correctly. For details, see “Selecting the Analog or Digital Input Mode” on page 20.

Notes:

- When shipped from the factory, the DIGITAL IN terminals have been set for use with the following components.
 - DIGITAL 1 (coaxial): For DVD player
 - DIGITAL 2 (optical): For CD player
 - DIGITAL 3 (optical): For digital TV broadcast tuner
 - DIGITAL 4 (optical): For CD recorder
- When you want to operate the CD player, CD recorder, or MD recorder using the COMPU LINK remote control system, connect the target component also as described in “Analog Connections” (see pages 5 and 6).
- When you want to operate the DVD player using the AV COMPU LINK remote control system, connect the DVD player also as described in “Analog Connections” (see page 7).

Digital input terminals

You can connect any digital equipment as follow.

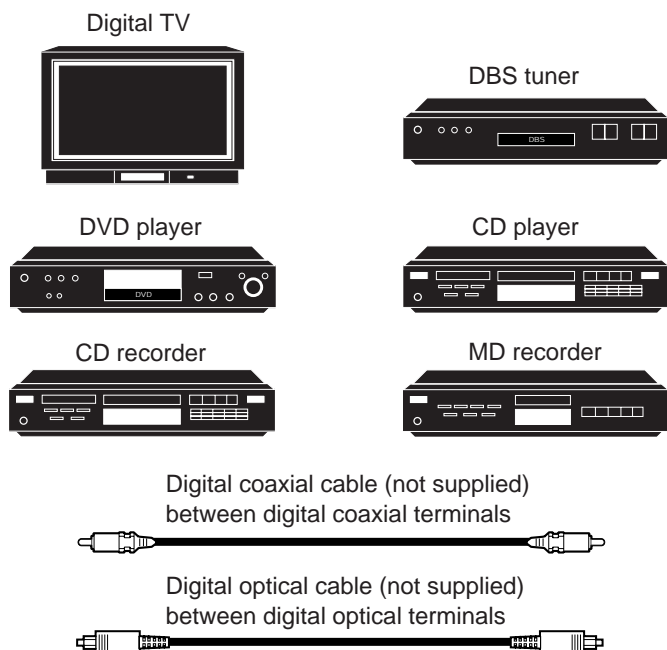

Digital output terminal

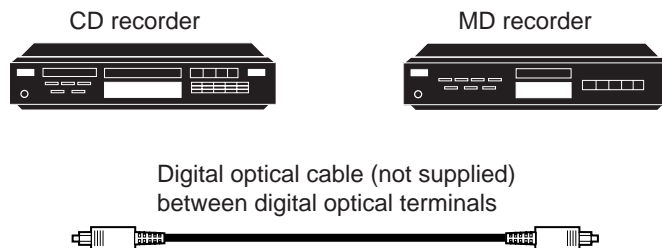

When the digital recording equipment such as an MD recorder and CD recorder has a digital optical input terminal, connecting it to the DIGITAL OUT terminal enables you to perform digital-to-digital recording.

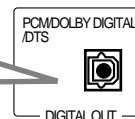

When the component has a digital coaxial output terminal, connect it to the DIGITAL 1 (DVD) terminal, using the digital coaxial cable (not supplied).

When the component has a digital optical output terminal, connect it to the DIGITAL 2 (CD), DIGITAL 3 (TV) or DIGITAL 4 (CDR) terminal, using the digital optical cable (not supplied).

Before connecting a digital optical cable, unplug the protective plug.

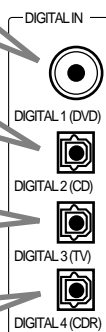
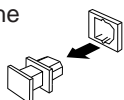

Note:

The digital signal format output through the DIGITAL OUT terminal is the same as that of the input signal. This means that when the DTS Digital Surround signals are input, the DTS Digital Surround signals are output.

USB Connection

This receiver is equipped with a USB terminal on the front panel. You can connect your PC to this terminal and enjoy sound reproduced through your PC.

When you connect your PC for the first time, follow the procedure below.

- Remember you cannot send any signal or data to your PC from this receiver.

IMPORTANT

- Check if your PC equipped with the CD-ROM drive is running on Windows® 98*, Windows® Me*, or Windows® 2000* and prepare its CD-ROM.
- Check your PC's BIOS setting — whether USB is available, and whether USB IRQ is set to "AUTO" or to available IRQ number.

How to install the USB drivers

The following procedure is described using the English version of Windows® 98. If your PC is running on a different version of Windows, the screens shown on your PC's monitor will differ from the ones used in the following procedure.

1. Turn on your PC and start running Windows® 98, Windows® Me or Windows® 2000.

If the PC has been turned on, quit all the applications now running.

2. Turn on the receiver, and press **USB AUDIO** on the front panel or **USB** on the remote control.

The lamp on the USB AUDIO button lights up.

3. Connect the receiver to the PC using a USB cable (not supplied).

Your PC automatically recognizes this connection, and shows the following screen on the monitor.

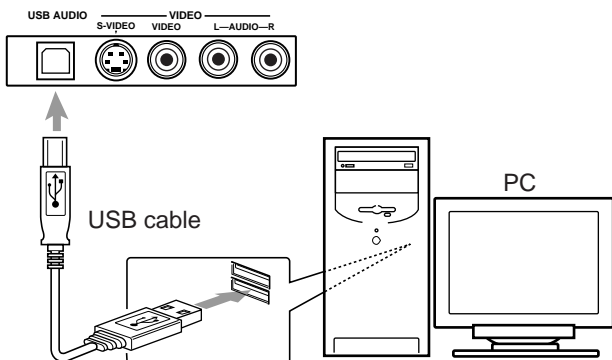

4. Install the USB drivers following the instructions on the PC's monitor.

5. Check if the drivers are correctly installed.

1. Open the Control Panel on your PC: Select [Start] → [Settings] → [Control Panel]
2. Select [System], then [Device Manager] and click [Sound, video and game controllers] and [Universal Serial Bus controllers.]

The following window appears, and you can check whether the drivers are installed.

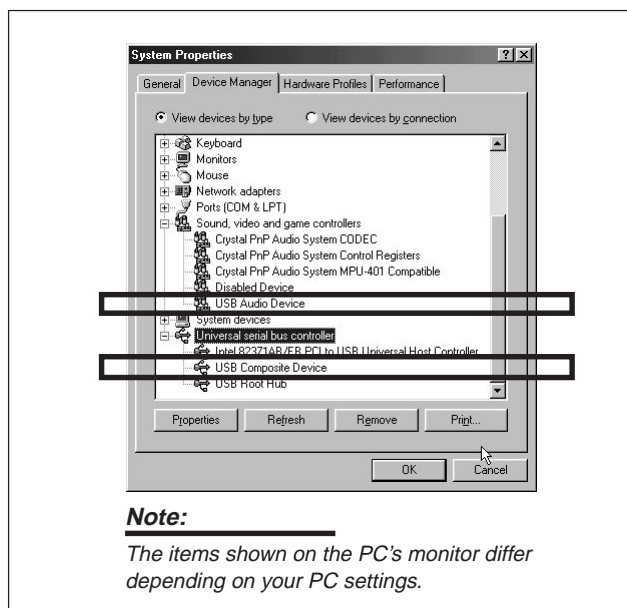

6. Change the PC audio setting.

1. If you have closed Control Panel, open it again: Select [Start] → [Settings] → [Control Panel]
2. Click [Multimedia], then select "USB Audio Device [1]" for "Playback" of "Audio," and close the window.

To play back a CD from CD-ROM drive on PC, click [Multimedia], [CD Music] then check [Enable digital CD audio for this CD-ROM device].

Now PC is ready for playback through the USB connection.

After installation is completed, you can use your PC as the playback source. The PC automatically recognizes the receiver whenever a USB cable is connected between the PC and the receiver while the receiver is turned on.

- When not using the PC as the playback source, disconnect the USB cable.

To play back sounds on the PC, refer to the manuals supplied with the sound reproduction application installed in the PC.

Notes:

- DO NOT turn off the receiver or disconnect the USB cable while installing the drivers and for a several seconds each time your PC is recognizing the receiver.
- Use a full speed USB cable (revision 1.0).
- If your PC does not recognize the receiver, disconnect the USB cable and connect it again. If this does not work, restart Windows.
- The drivers installed can be recognized only when the USB cable is connected between the receiver and your PC.
- The sound may not be played back correctly — interrupted or degraded — due to your PC settings and PC specifications.

* Microsoft®, Windows® 98, Windows® Me and Windows® 2000 are registered trademarks of Microsoft Corporation.

Connecting the Power Cord

Before plugging the receiver into an AC outlet, make sure that all connections have been made.

Plug the power cord into an AC outlet.

Keep the power cord away from the connecting cables and the antenna. The power cord may cause noise or screen interference. We recommend that you use a coaxial cable to connect the antenna, since it is well-shielded against interference.

Notes:

- The preset settings such as preset channels and sound adjustment may be erased in a few days in the following cases:
 - When you unplug the power cord.
 - When a power failure occurs.
- If the wall outlet does not match the AC plug, use the supplied AC plug adaptor.

CAUTIONS:

- Do not plug in before setting the voltage selector switch on the rear of the unit and all connection procedures are complete.
- Do not touch the power cord with wet hands.
- Do not pull on the power cord to unplug the cord. When unplugging the cord, always grasp the plug so as not to damage the cord.

Putting Batteries in the Remote Control

Before using the remote control, put two supplied batteries first. When using the remote control, aim the remote control directly at the remote sensor on the receiver.

1. On the back of the remote control, remove the battery cover.

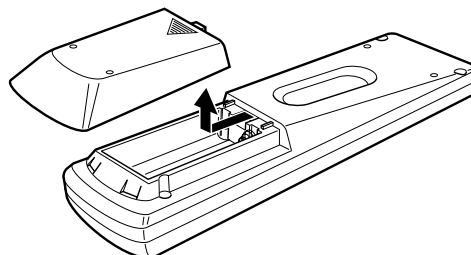

2. Insert batteries. Make sure to match the polarity: (+) to (+) and (-) to (-).

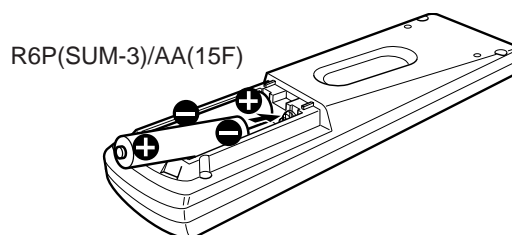

3. Replace the cover.

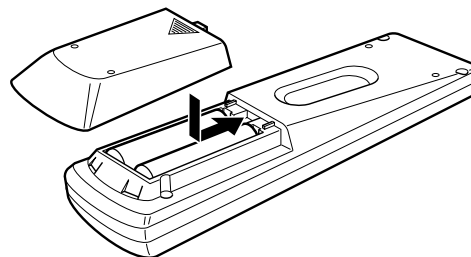

If the range or effectiveness of the remote control decreases, replace the batteries. Use two R6P(SUM-3)/AA(15F) type dry-cell batteries.

Note:

After replacing the batteries, set the manufacturers' codes again (see page 52).

CAUTION:

Follow these precautions to avoid leaking or cracking cells:

- Place batteries in the remote control so they match the polarity: (+) to (+) and (-) to (-).
- Use the correct type of batteries. Batteries that look similar may differ in voltage.
- Always replace both batteries at the same time.
- Do not expose batteries to heat or flame.

Basic Operations

The following operations are commonly used when you play any sound source.

Before using the remote control

How to confirm the remote control operation mode

The display window on the remote control shows following information for about 10 seconds when you press certain buttons on the remote control, so that you can confirm which operation you do.

Pressing one of the source selecting buttons, the source name selected appears on the display.

Buttons	Indications
FM/AM	TUNER
CD	CD
PHONO	PHONO
TAPE/MD	TAPE
DVD or DVD MULTI	DVD
CDR	CDR
USB	USB
TV/DBS	TV
VCR 1	VCR 1
VCR 2	VCR 2
VIDEO	VIDEO

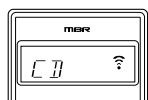

Ex.: When you press CD.

Pressing SOUND before you adjust the sound effect, "SOUND" appears on the display.



Pressing TEXT DISPLAY or MENU before you use on-screen menu or TEXT COMPUTE LINK, "MENU" appears on the display (see pages 36 and 43).



Pressing CONTROL or CATV/DBS CONTROL before you operate an audio or video equipment connected to the receiver, the remote control operation mode selected appears on the display (see pages 49 and 52).

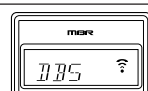

Ex.: When you press CATV/DBS CONTROL.

Turning the Power On and Off (Standby)

On the front panel:

To turn on the power, press STANDBY/ON .

The STANDBY lamp goes off. The name of the current source and Surround/DSP mode appear on the display.

Current source name and Surround/DSP mode appear

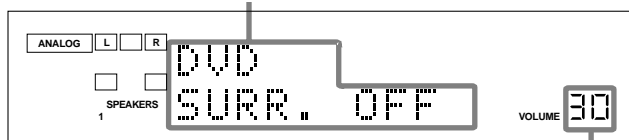

Current volume level appears

To turn off the power (into standby mode), press STANDBY/ON again.

The STANDBY lamp lights up. A small amount of power is consumed in standby mode. To turn the power off completely, unplug the AC power cord.

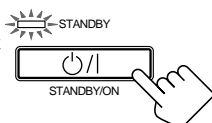

From the remote control:

To turn on the power, press AUDIO .

The STANDBY lamp on the front panel goes off.

The name of the current source and Surround/DSP mode appear on the display.



To turn off the power (into standby mode), press AUDIO again.

The STANDBY lamp on the front panel lights up.

Selecting the Source to Play

Press one of the source selecting buttons.

The lamp on the front panel button for selected source lights up.

- The selected source name and Surround/DSP mode also appear on the display.

On the front panel:

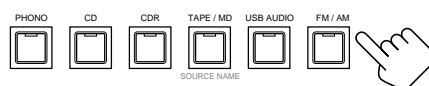
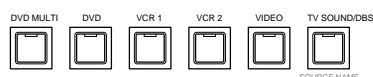

From the remote control:

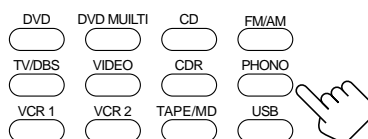

Selected source name and current Surround/DSP mode appear

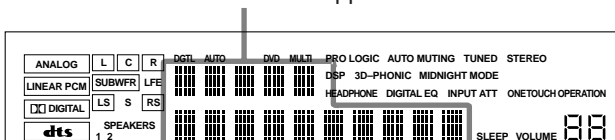

DVD MULTI

Select the DVD player for viewing the digital video disc using the analog discrete output mode (5.1CH reproduction).

To enjoy the DVD MULTI playback, see page 35.

DVD

Select the DVD player.

VCR 1

Select the video component connected to the VCR 1 terminals.

VCR 2

Select the video component connected to the VCR 2 terminals.

VIDEO

Select video component connected to the VIDEO terminals.

TV (SOUND)/DBS

Select TV sounds (or the DBS tuner).

PHONO *

Select the turntable.

CD *

Select the CD player.

CDR *

Select the CD recorder.

TAPE/MD *

Select the cassette deck (or the MD recorder).

USB (AUDIO) *

Select the personal computer (PC) connected to the USB terminal.

FM/AM *

Select an FM or AM broadcast.

- Each time you press the button, the band alternates between FM and AM.

Notes:

- When connecting an MD recorder (to the TAPE/MD jacks), and a DBS tuner (to the TV SOUND/DBS jacks), change the source names shown on the display. For details, see page 16.
- When you press one of the source selecting buttons on the remote control marked with an asterisk (*), the receiver automatically turns on.

Signal and speaker indicators on the display**The signal indicators light up in the following cases:**

- Only the indicators for the incoming signals light up.
- When analog input is selected, “L” and “R” always light up.
- When “DVD MULTI” is selected as the source, “L,” “C,” “R,” “LFE,” “LS” and “RS” light up.

The speaker indicators light up only —:

The frames of “C,” “LS,” and “RS” light up, when the corresponding speaker is set to “LARGE” or “SMALL”.

Signal indicators light up in red:	Speaker indicators light up in white:

- L: • **When digital input is selected:** Lights up when the left channel signal comes in.
 • **When analog input is selected:** Always lights up.
- R: • **When digital input is selected:** Lights up when the right channel signal comes in.
 • **When analog input is selected:** Always lights up.
- C: Lights up when the center channel signal comes in.
- LS: Lights up when the left rear channel signal comes in.
- RS: Lights up when the right rear channel signal comes in.
- S: Lights up when the monaural rear channel signal comes in.
- LFE: Lights up when the LFE channel signal comes in.

Note:

When “SUBWOOFER” is set to “YES,” lights up (see page 17).

Selecting different sources for picture and sound

You can watch picture from a video component while listening to sound from another component.

Press one of the audio source selecting buttons — PHONO, CD, CDR, TAPE/MD, USB(AUDIO), FM/AM — while viewing the picture from a video component such as the VCR or DVD player, etc.

The lamp on the front panel button for selected source lights up.

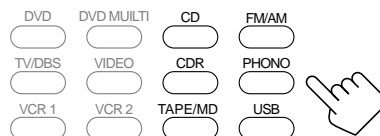
On the front panel:**From the remote control:****Note:**

Once you have selected a video source, pictures of the selected source are sent to the TV until you select another video source.

Adjusting the Volume**On the front panel:**

To increase the volume, turn MASTER VOLUME clockwise.

To decrease the volume, turn it counterclockwise.

- When you turn MASTER VOLUME rapidly, the volume level also changes rapidly.
- When you turn MASTER VOLUME slowly, the volume level also changes slowly.

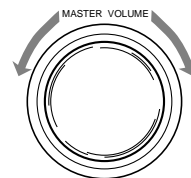
**From the remote control:**

To increase the volume, press VOLUME +.

To decrease the volume, press VOLUME -.

**CAUTION:**

Always set the volume to the minimum before starting any source. If the volume is set at its high level, the sudden blast of sound energy can permanently damage your hearing and/or ruin your speakers.

Notes:

- The volume level can be adjusted within the range of “0” (minimum) to “90” (maximum).
- If you set One Touch Operation to “ON” (see page 21), you do not have to adjust the volume level each time you change the source. It is automatically set to the stored level.

Selecting the Front Speakers

On the front panel ONLY:

When you have connected two pairs of the front speakers, you can select which to use.

To use the speakers connected to the FRONT SPEAKERS ① terminals, press SPEAKERS ON/OFF 1 so that SPEAKERS 1 indicator lights up on the display. Make sure that the SPEAKERS 2 is not lit on the display.

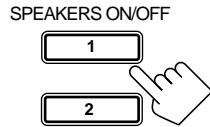

To use the speakers connected to the FRONT SPEAKERS ② terminals, press SPEAKERS ON/OFF 2 so that SPEAKERS 2 indicator lights up on the display. Make sure that the SPEAKERS 1 is not lit on the display.

To use both sets of the speakers, press SPEAKERS ON/OFF 1 and 2 so that the SPEAKERS 1 and SPEAKERS 2 indicators light up on the display.

To use neither sets of the speakers, press SPEAKERS ON/OFF 1 and 2 so that the SPEAKERS 1 and SPEAKERS 2 indicators disappear from the display.

The HEADPHONE indicator lights up and "HEADPHONE" appears on the display.

- Activating the speaker turns on the Surround and DSP modes previously selected.
- **Listening only with headphones:** You can listen with the headphones without deactivating both pairs of speakers by connecting a pair of headphones to the PHONES jack on the front panel. If you want to use a pair of headphones without outputting sounds from the front speakers, you must turn off both pairs of the front speakers as mentioned above.

Notes:

- If you use any of the Surround and DSP modes using the center or rear speakers with both front speakers activated, the speakers connected to the FRONT SPEAKERS ② terminals are deactivated.
- When you use HEADPHONE DSP mode, you can enjoy spacious stereo effect (see page 25).

CAUTION:

Be sure to turn down the volume before connecting or putting on headphones, as high volume can damage both the headphones and your hearing.

Muting the Sound

From the remote control ONLY:

Press MUTING to mute the sound through all speakers and headphones connected.

"MUTING" appears on the display and the volume turns off (the volume level indicator goes off).



To restore the sound, press MUTING again so that "MUTING OFF" appears on the display.

- Turning MASTER VOLUME on the front panel or pressing VOLUME +/- on the remote control also restores the sound.

Listening at Night — Midnight Mode

Using the midnight mode, you can enjoy a powerful sound at night even at a low volume level.

- You can do this setting for each source.

Press MIDNIGHT MODE to select the midnight mode.

MIDNIGHT MODE

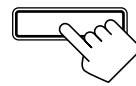

On the front panel

MIDNIGHT MODE

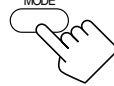

From the remote control

- Each time you press the button, the midnight mode changes as follow.

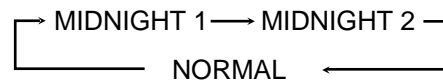

MIDNIGHT 1: Select this when you want to compress the dynamic range a little.

The MIDNIGHT MODE indicator lights up on the display.

MIDNIGHT 2: Select this when you want to compress the dynamic range fully. (Useful at midnight).

The MIDNIGHT MODE indicator lights up on the display.

NORMAL: Select this when you want to enjoy sound with its full dynamic range. (No effect applied.)

The MIDNIGHT MODE indicator goes off from the display.

Notes:

- When the line direct function is turned on, the midnight mode is canceled temporarily.
- The midnight mode is not valid for the DVD MULTI playback mode.

Activating the Subwoofer Sound

You can cancel the subwoofer sound even though you have connected a subwoofer and have set “SUBWOOFER” to “YES” (see page 17). This is useful when enjoying surround sound at night.

On the front panel ONLY:

Press **SUBWOOFER OUT ON/OFF** to cancel the subwoofer sound output.

Each time you press the button, the subwoofer sound output is deactivated (“SUBWFR OFF”) or activated (“SUBWFR ON”).

- Select “SUBWFR OFF” to deactivate the subwoofer sound output.
- Select “SUBWFR ON” to activate it.



Note:

You cannot select “SUBWFR OFF” even though “SUBWOOFER” is set to “YES,” when “SMALL” is selected for the front speakers (see page 17.)

Reinforcing the Bass

You can boost the bass level.

- You can do this setting for each source.

On the front panel:

Press **BASS BOOST** to select the bass boost function.

The BASS BOOST lamp on the front panel button lights up.

- Each time you press the button, the bass boost function turns on (“BOOST ON”) and off (“BOOST OFF”).
 - Select “BOOST ON” to activate the bass boost function. The BASS BOOST lamp on the front panel button lights up.
 - Select “BOOST OFF” to cancel it. The BASS BOOST lamp on the front panel button goes off.

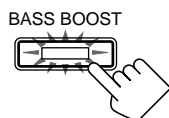

From the remote control:

1. Press **SOUND**.

The 10 keys are activated for sound adjustments.

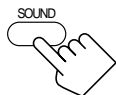

2. Press **BASS BOOST** to select the bass boost function.

The BASS BOOST lamp on the front panel button lights up.

- Each time you press the button, the bass boost function turns on (“BOOST ON”) and off (“BOOST OFF”).
 - Select “BOOST ON” to activate the bass boost function. The BASS BOOST lamp on the front panel button lights up.
 - Select “BOOST OFF” to cancel it. The BASS BOOST lamp on the front panel button goes off.



Note:

This function does not affect the sounds outputting from the rear speakers.

Attenuating the Input Signal

When the input level of the playing source is too high, the sounds will be distorted. If this happens, you need to attenuate the input signal level to prevent the sound distortion.

- You can do this setting for each source.

On the front panel ONLY:

Press and hold **INPUT ATT (INPUT ANALOG/DIGITAL)** so that the **INPUT ATT** indicator lights up on the display.

- Each time you press and hold the button, the input attenuator mode turns on (“ATT ON”) or off (“NORMAL”).

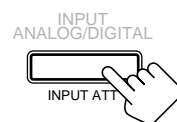

Notes:

- This function is available only for the sources connected using the analog terminals.
- When selecting “DVD MULTI” as the source, this effect does not work.

Selecting the Line Direct Function

You can enjoy the sound closer to original source by skipping the sound adjustments such as digital equalization and midnight mode. Only the volume level and bass boost function are adjustable when the line direct function is turned on.

- You can do this setting for each source.

Press LINE DIRECT.

The LINE DIRECT lamp on the front panel button lights up.

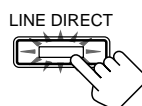

On the front panel



From the remote control

- Each time you press the button, the line direct function turns on (“DIRECT ON”) and off (“DIRECT OFF”).
 - Select “DIRECT ON” to activate the line direct function. The LINE DIRECT lamp on the front panel button lights up.
 - Select “DIRECT OFF” to cancel it. The LINE DIRECT lamp on the front panel button goes off.

Notes:

- If you turn on the line direct function while using the Surround and DSP modes, the effect changes as follows:

Input \ Mode	Surround	DSP
Analog	Not valid	Not valid
Digital	Valid	Not valid

- Turning off the line direct function activates the sound adjustments previously selected such as the digital equalization and midnight mode.

Adjusting the Equalization Patterns

You can adjust equalization to your preference.

- You can do this setting for each source.

Before you start, remember....

- There is a time limit in doing the following steps. If the setting is canceled before you finish, start from step 1 again.

On the front panel:

- Press **DIGITAL EQ (Equalization)** repeatedly to select the frequency.

- Each time you press the button, the frequency with its current level changes as follows:

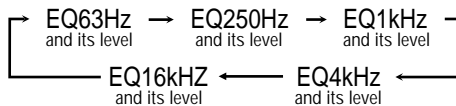

- Press **CONTROL UP ▲/DOWN ▼** repeatedly to adjust the frequency level.

The frequency level changes by 2 dB from -8 dB to +8 dB. The DIGITAL EQ indicator lights up on the display.

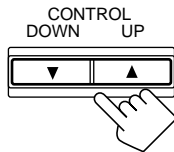

- Repeat Steps 1 and 2 to adjust the other frequency level.

To flat the equalization pattern,

Set all the frequency levels to "0" in step 2. The DIGITAL EQ indicator goes off from the display.

From the remote control:

- Press **SOUND**.

The 10 keys are activated for sound adjustments.

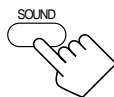

- Press **DIGITAL EQ (Equalization)** repeatedly to select the frequency you want.

"EQ" appears on the remote control display window.

- Each time you press the button, the frequency with its level changes as follows:

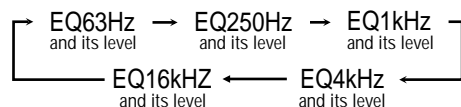

- Press **LEVEL + or -** repeatedly to adjust the frequency level.

The frequency level changes by 2 dB from -8 dB to +8 dB. The DIGITAL EQ indicator lights up on the display.

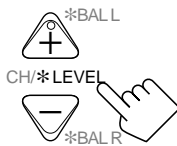

- Repeat steps 2 and 3 to adjust the other frequency level.

To flat the equalization pattern,

Set all the frequency levels to "0" in step 3. The DIGITAL EQ indicator goes off from the display.

Notes:

- When the line direct function is turned on, the digital equalization cannot be adjusted.
- The digital equalization affects the front speaker sounds only.

Using the Sleep Timer

Using the Sleep Timer, you can fall asleep to music and know the receiver will turn off by itself rather than play all night.

From the remote control ONLY:

Press SLEEP repeatedly.

The SLEEP indicator lights up on the display, and the shut-off time changes as follows (in minutes):

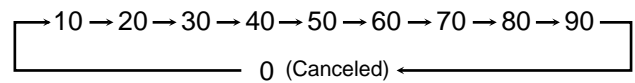

When the shut-off time comes

The receiver turns off automatically.

To check or change the time remaining until the shut-off time

Press SLEEP once.

The remaining time until the shut-off time appears in minutes.

- To change the shut-off time, press SLEEP repeatedly.

To cancel the Sleep Timer

Press SLEEP repeatedly until "SLEEP 0min" appears on the display. (The SLEEP indicator goes off.)

- Turning off the power also cancels the Sleep Timer.

Recording a Source

For analog-to-analog recording

You can record any analog source through the receiver to —

- the cassette deck (or MD recorder) connected to the TAPE/MD jacks,
 - the VCRs connected to the VCR 1 and VCR 2 jacks, and
 - the CD recorder connected to the CDR jacks
- at the same time.

For digital-to-digital recording

You can record the currently selected digital input source through the receiver to a digital recording device connected to the DIGITAL OUT terminal.

Notes:

- Analog-to-digital and digital-to-analog recordings are not possible.
- The output volume level, midnight mode (see page 13), bass boost (see page 14), digital equalization (see the left), Surround modes and DSP modes (see page 24) cannot affect the recording.
- The test tone signal (see page 27) does not come out through the DIGITAL OUT terminal.

Basic Settings

Some of the following settings are required after connecting and positioning your speakers in your listening room, while others will make operations easier.

Adjusting the Front Speaker Output Balance

If the sounds you hear from the front right and left speakers are unequal, you can adjust the speaker output balance.

- You can do this setting for each source.

Before you start, remember....

- There is a time limit in doing the following steps. If the setting is canceled before you finish, start from step 1 again.

On the front panel:

1. Press **LEVEL ADJUST** repeatedly until “BAL- (with current setting)” appears on the display.



2. Press **CONTROL UP ▲/DOWN ▼** to adjust the balance.

- Pressing **CONTROL UP ▲** decreases the left channel output (from CENTER to L-21).
- Pressing **CONTROL DOWN ▼** decreases the right channel output (from CENTER to R-21).

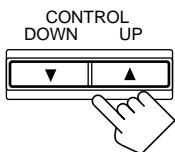

From the remote control:

1. Press **SOUND**.

The 10 keys are activated for sound adjustments.

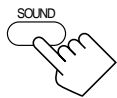

2. Press **L/R BAL**.

“L/R” appears on the remote control display window.



3. Press **BAL L** or **BAL R** to adjust the balance.

- Pressing **BAL L** decreases the right channel output (from CENTER to R-21).
- Pressing **BAL R** decreases the left channel output (from CENTER to L-21).

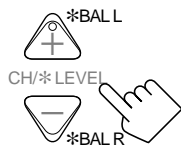

Changing the Source Name

When you have connected an MD recorder to the TAPE/MD jacks or the DBS tuner to the TV SOUND/DBS jacks on the rear panel, change the source name which will be shown on the display when you select the MD recorder or DBS tuner as the source.

On the front panel ONLY:

When changing the source name from “TAPE” to “MD”:

- Press and hold **SOURCE NAME (TAPE/MD)** until “ASSGN. MD” appears on the display.



When changing the source name from “TV” to “DBS”:

- Press and hold **SOURCE NAME (TV SOUND/DBS)** until “ASSGN. DBS” appears on the display.

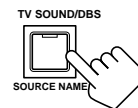

To change the source name to “TAPE” or “TV,” repeat the same procedure above — press and hold **SOURCE NAME (TAPE/MD)** to select “TAPE,” or press and hold **SOURCE NAME (TV SOUND/DBS)** to select “TV.”

Note:

Without changing the source name, you can still use the connected components. However, there may be some inconvenience.

- “TAPE” or “TV” will appear on the display when you select the MD recorder or DBS tuner.
- You cannot use the digital input (see page 19) for the MD recorder.
- You cannot use the **COMPU LINK** remote control system (see page 41) to operate the MD recorder.

Selecting the Video Input Terminal

This receiver is equipped with the component video input terminals for the DVD player and DBS tuner, which give you higher picture quality. When you use the component video input terminals for the DVD player and/or DBS tuner, change the video input terminal setting.

Before you start, remember....

- There is a time limit in doing the following steps. If the setting is canceled before you finish, start from step 1 again.

On the front panel ONLY:

1. Press **SETTING** repeatedly until “VIDEO DVD” or “VIDEO DBS” appears on the display.

The display changes to show the current setting.

- Select “VIDEO DVD” to select the video input terminal for the DVD player and “VIDEO DBS” for the DBS tuner.

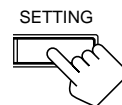

2. Press **CONTROL UP ▲/DOWN ▼** to select the appropriate video input terminal.

- Each time you press the button, the display changes to show the following:

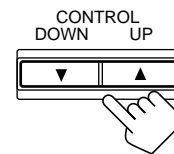

COMPNT (Component) ← S/C (S-video/Composite)

COMPNT: Select this when you connect the DVD player or DBS tuner to the component video input terminals.

S/C: Select this when you connect the DVD player or DBS tuner to the composite video or S-video input terminal.

Note:

Without changing the video input terminal setting, you can see the picture through the video input terminals, but cannot use the **AV COMPU LINK** remote control system correctly (see page 47).

Setting the Subwoofer Information

Register whether you have connected a subwoofer or not.

Before you start, remember....

- There is a time limit in doing the following steps. If the setting is canceled before you finish, start from step 1 again.

On the front panel ONLY:

1. Press **SETTING** repeatedly until “SUBWOOFER” appears on the display.

The display changes to show the current setting.

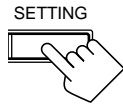

2. Press **CONTROL UP ▲/DOWN ▼** to select “YES” or “NO.”

- Each time you press the button, the display alternates between “YES” and “NO.”

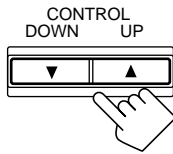

YES: Select this when a subwoofer is connected.

NO: Select this when no subwoofer is used.

Note:

You cannot use **SUBWOOFER OUT ON/OFF** on the front panel (see page 14) and adjust the subwoofer output level (see below) when “SUBWOOFER” is set to “NO.”

Adjusting the Subwoofer Output Level

You can adjust the subwoofer output level if you have selected “YES” for the “SUBWOOFER” (see above).

Once it has been adjusted, the receiver memorizes the adjustment.

- You can do this setting for each source.

Before you start, remember....

- There is a time limit in doing the following steps. If the setting is canceled before you finish, start from step 1 again.
- When the front speakers are all deactivated, the subwoofer level cannot be adjusted.

On the front panel:

1. Press **LEVEL ADJUST** repeatedly until “SUBWFR” appears on the display.

The display changes to show the current setting.



2. Press **CONTROL UP ▲/DOWN ▼** to adjust the subwoofer output level (from -20 dB to +10 dB).

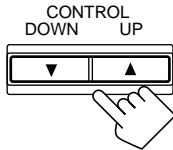

From the remote control:

1. Press **SOUND**.

The 10 keys are activated for sound adjustments.

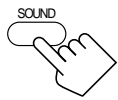

2. Press **SUBWFR**.

“S-WFR” appears on the remote control display window.



3. Press **LEVEL +/-** to adjust the subwoofer output level (from -20 dB to +10 dB).



Setting the Speakers for a Surround Field

To obtain the best possible surround sound of the Surround and DSP modes, you have to register the information about the speakers arrangement after all connections are completed.

Before you start, remember....

- There is a time limit in doing the following steps. If the setting is canceled before you finish, start from step 1 again.

Front, Center, and Rear Speaker Setting

Register the sizes of all the connected speakers.

- When you change your speakers, you need to register the information about the speakers again.

On the front panel ONLY:

1. Press **SETTING** repeatedly until “FRONT SPK” (Front Speaker), “CTR SPK” (Center Speaker) or “REAR SPK” (Rear Speaker) appears on the display.

The display changes to show the current setting.

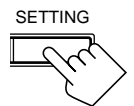

2. Press **CONTROL UP ▲/DOWN ▼** to select the appropriate item about the speaker selected in the above step.

- Each time you press the button, the display changes to show the following:

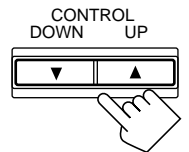

→ LARGE ↔ SMALL ↔ NONE ←

LARGE: Select this when the speaker size is relatively large.

SMALL: Select this when the speaker size is relatively small.

NONE: Select this when you have not connected a speaker. (Not selectable for the front speakers)

3. Repeat steps 1 and 2 to select the appropriate items for the other speakers.

Notes:

- Keep the following comment in mind as reference when adjusting.
 - If the size of the cone speaker unit built in your speaker is greater than 12 cm, select “LARGE,” and if it is smaller than 12 cm, select “SMALL.”
- If you have selected “NO” for the subwoofer setting, you can only select “LARGE” for the front speaker setting.
- If you have selected “SMALL” for the front speaker setting, you cannot select “LARGE” for the center and rear speaker settings.

Center Delay Time Setting

Register the delay time of the sound from the center speaker, comparing to that of the sound from the front speakers.

If the distance from your listening point to the center speaker is equal to that to the front speakers, select 0 ms. As the distance to the center speaker becomes shorter, increase the delay time.

- 1 msec increase (or decrease) in delay time corresponds to 30 cm decrease (or increase) in distance.
- When shipped from the factory, the delay time is set to 0 ms.

On the front panel ONLY:

1. Press **SETTING** repeatedly until “**CTR DELAY**” (Center Delay) appears on the display.

The display changes to show the current setting.

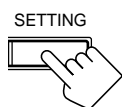

2. Press **CONTROL UP ▲/DOWN ▼** to select the delay time of the center speaker output (from 0 ms to 5 ms).

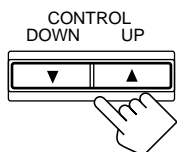

Notes:

- Center delay time is not valid for the DVD MULTI playback mode.
- You cannot adjust the center delay time when you have set “CTR SPK” to “NONE.”

Rear Delay Time Setting

Register the delay time of the sound from the rear speakers, comparing to that of the sound from the front speakers.

If the distance from your listening point to the rear speakers is equal to that to the front speakers, select 0 ms. As the distance to the rear speakers becomes shorter, increase the delay time.

- 1 msec increase (or decrease) in delay time corresponds to 30 cm decrease (or increase) in distance.
- When shipped from the factory, the delay time is set to 5 ms.

On the front panel ONLY:

1. Press **SETTING** repeatedly until “**REAR DELAY**” appears on the display.

The display changes to show the current setting.

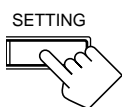

2. Press **CONTROL UP ▲/DOWN ▼** to select the delay time of the rear speaker output (from 0 ms to 15 ms).

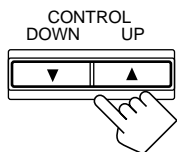

Notes:

- Rear delay time is not valid for the DVD MULTI playback mode.
- You cannot adjust the rear delay time when you have set “REAR SPK” to “NONE.”

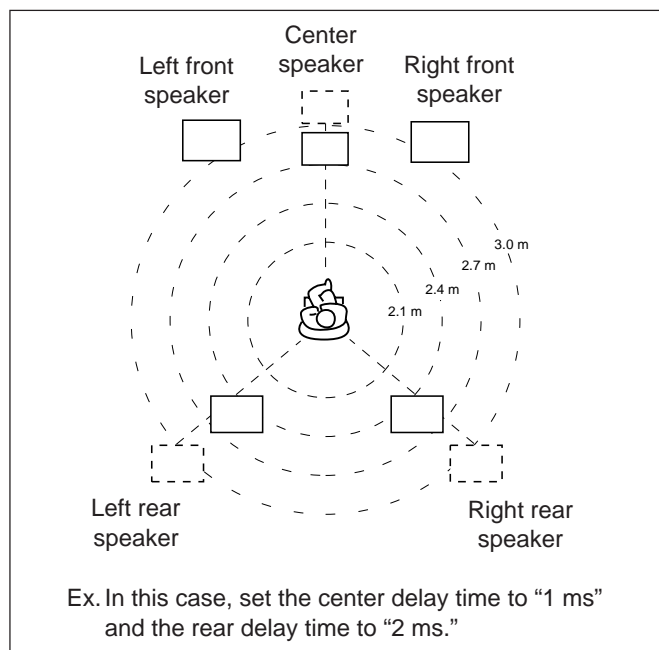

Crossover Frequency Setting

Small speakers cannot reproduce the bass sound very well. So, if you have used a small speaker for any of the front, center, and rear channels, this receiver automatically reallocates the bass elements, originally assigned to the channel for which you have connected the small speaker, to another channel (for which you have connected the large speaker).

To use this function properly, you need to set the crossover frequency level according to the size of the small speaker connected.

- If you have selected “LARGE” for all speakers (see page 17), this function cannot be adjusted.

On the front panel ONLY:

1. Press **SETTING** repeatedly until “**CROSS OVER**” appears on the display.

The display changes to show the current setting.

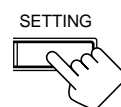

2. Press **CONTROL UP ▲/DOWN ▼** to select the crossover frequency level according to the size of the small speaker connected.

- Each time you press the button, the display changes to show the following:

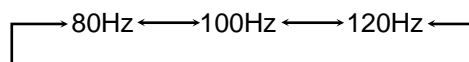

- Use the following comments as reference when adjusting.

80Hz: Select this when the cone speaker unit built in the speaker is about 12 cm.

100Hz: Select this when the cone speaker unit built in the speaker is about 10 cm.

120Hz: Select this when the cone speaker unit built in the speaker is about 8 cm.

Note:

Crossover frequency is not valid for the DVD MULTI playback, 5 CH / 4 CH Stereo, 3D-PHONIC, and HEADPHONE DSP modes.

Low Frequency Effect Attenuator Setting

If the bass sound is distorted while playing back a source using Dolby Digital or DTS Digital Surround, follow the procedure below.

On the front panel ONLY:

1. Press **SETTING** repeatedly until **"LFE ATT" (Low Frequency Effect Attenuator)** appears on the display.

The display changes to show the current setting.

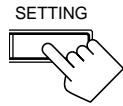

2. Press **CONTROL UP ▲/DOWN ▼** to select the low frequency effect attenuator level.

- Each time you press the button, the display changes to show the following:

0dB ←→ 10dB

0dB:	Normally select this.
10dB:	Select this when the bass sound is distorted.

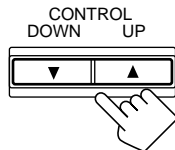

Notes:

- Low frequency effect attenuator is not valid for the DVD MULTI playback mode.
- This function takes effect only when the Dolby Digital or DTS Digital Surround sounds with LFE signal comes in (with "SUBWOOFER" set to "YES").

Digital Input (DIGITAL IN) Terminal Setting

When you use the digital input terminals, you have to register what components are connected to which terminals (DIGITAL IN 1/2/3/4).

Before you start, remember...

- There is a time limit in doing the following steps. If the setting is canceled before you finish, start from step 1 again.

On the front panel ONLY:

To set the DIGITAL 1 terminal:

1. Press **SETTING** repeatedly until **"DGTL COAX" (Digital Coaxial)** appears on the display.

The display changes to show the current setting for DIGITAL 1 terminal.

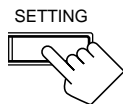

2. Press **CONTROL UP ▲/DOWN ▼** to select the appropriate digital terminal setting.

- Each time you press the button, the display changes to show the following:

1: DVD ⇐ 1: MD** ⇐ 1: CDR ⇐ 1: TV (or DBS*) ⇐
1: CD ⇐ (back to the beginning)

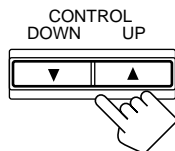

* If you have changed the source name from "TV" to "DBS," "DBS" appears (see page 16).

** Change the source name to "MD" for TAPE/MD jacks when you use an MD recorder (see page 16).

To set the DIGITAL 2/3/4 terminals:

1. Press **SETTING** again until **DIGITAL 2/3/4 terminals' setting** appears on the display.

The display changes to show the current settings.

DIGITAL 2 terminal setting

2: CD 3: TV 4: CDR

DIGITAL 3 terminal setting DIGITAL 4 terminal setting

2. Press **CONTROL UP ▲/DOWN ▼** to select the appropriate digital terminal settings.

- Each time you press the buttons, the display changes to show the following:

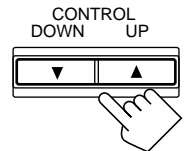

When the DGTL COAX (DIGITAL 1) is set to "DVD"

2: CD 3: TV (or DBS*) 4: CDR ⇐
2: CD 3: TV (or DBS*) 4: MD** ⇐
2: CD 3: MD** 4: CDR ⇐
2: MD** 3: TV (or DBS*) 4: CDR ⇐
(back to the beginning)

When the DGTL COAX (DIGITAL 1) is set to "MD"***

2: CD 3: TV (or DBS*) 4: DVD ⇐
2: CD 3: DVD 4: CDR ⇐
2: DVD 3: TV (or DBS*) 4: CDR ⇐
2: CD 3: TV (or DBS*) 4: CDR ⇐
(back to the beginning)

When the DGTL COAX (DIGITAL 1) is set to "CDR"

2: MD** 3: TV (or DBS*) 4: DVD ⇐
2: CD 3: TV (or DBS*) 4: DVD ⇐
2: CD 3: TV (or DBS*) 4: MD** ⇐
2: CD 3: MD** 4: DVD ⇐
(back to the beginning)

When the DGTL COAX (DIGITAL 1) is set to "TV" or "DBS"

2: CD 3: MD** 4: CDR ⇐ 2: MD** 3: DVD 4: CDR ⇐
2: CD 3: DVD 4: CDR ⇐ 2: CD 3: DVD 4: MD** ⇐
(back to the beginning)

When the DGTL COAX (DIGITAL 1) is set to "CD"

2: DVD 3: TV (or DBS*) 4: MD** ⇐
2: DVD 3: MD** 4: CDR ⇐
2: MD** 3: TV (or DBS*) 4: CDR ⇐
2: DVD 3: TV (or DBS*) 4: CDR ⇐
(back to the beginning)

* If you have changed the source name from "TV" to "DBS," "DBS" appears (see page 16).

** Change the source name to "MD" for TAPE/MD jacks when you use an MD recorder (see page 16).

Note:

When shipped from the factory, the DIGITAL IN terminals have been set for use with the following components.

- DIGITAL 1 (coaxial): For DVD player
- DIGITAL 2 (optical): For CD player
- DIGITAL 3 (optical): For digital TV broadcast tuner
- DIGITAL 4 (optical): For CD recorder

Selecting the Analog or Digital Input Mode

When you have connected digital source components using the digital terminals (see page 8), you need to change the input mode for these components to the appropriate digital input mode correctly — DGTL AUTO, DGTL DTS, or DGTL D.D.

Before you start, remember...

- The digital input (DIGITAL IN) terminal setting should be correctly done for the sources you want to select the digital input mode for. Without setting this digital input terminal correctly, you cannot change the input mode from analog input to digital input even if you follow the procedure below.

On the front panel:

1. Press one of the source selecting button (DVD, TV SOUND/DBS, CD, CDR, or TAPE/MD)* for which you want to change the input mode.

The lamp on the front panel button for selected source lights up.

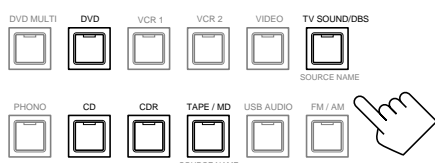

Note:

* Among the source listed above, you can select the digital input only for the sources which you have selected the digital input terminals for. (See "Digital Input (DIGITAL IN) Terminal Setting" on page 19.)

2. Press INPUT ANALOG/DIGITAL (INPUT ATT) briefly to change the input mode.

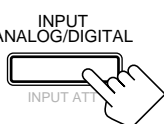

- Each time you press the button, the input mode changes as follows.

DGTL AUTO (Digital) ↔ ANALOG

DGTL AUTO: Select this for the digital input mode. The receiver automatically detects the incoming signal.

ANALOG: Select this for the analog input mode.

ANALOG always lights up.

When selecting "DGTL AUTO," following indicators showing detected signals light up on the display.

DGTL AUTO	: Always lights up.
LINEAR PCM	: • Lights up when Linear PCM signals come in. • The frame flashes when detecting signals. • LINEAR PCM without frame flashes when PCM signals are not recognized.
DIGITAL	: Lights up when Dolby Digital signals come in.
dts	: Lights up when DTS Digital Surround signals come in.

When playing a software encoded with the Dolby Digital or DTS Digital Surround, "DGTL AUTO" may not work properly and the following symptoms may occur:

- Sound does not come out at the beginning of playback.
- Noise comes out while using the searching or skipping chapters or tracks.

In this case press CONTROL UP ▲/DOWN ▼ to select "DGTL D.D" or "DGTL DTS" while "DGTL AUTO" still remains on the display.

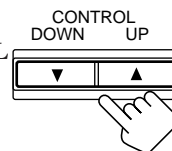

- Each time you press the button, the input mode changes as follows.



When selecting "DGTL D.D" or "DGTL DTS," following indicators showing detected signals light up on the display.

DGTL : Always lights up.

When selecting "DGTL D.D"

DIGITAL : • Lights up when Dolby Digital signals come in.
• The frame flashes when Dolby Digital signals are not recognized.

When selecting "DGTL DTS"

dts : • Lights up when DTS Digital Surround signals come in.
• The frame flashes when DTS Digital Surround signals are not recognized.

Note:

When you turn off the power or select another source, "DGTL D.D" and "DGTL DTS" settings are canceled and the digital input mode is automatically reset to "DGTL AUTO."

To change the input mode back to analog input, select "ANALOG" in step 2.

From the remote control:

1. Press the source selecting button (DVD, CD, TV/DBS, CDR, or TAPE/MD)* for which you want to change the input mode.

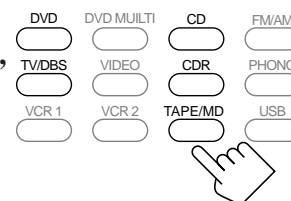

Note:

* Among the source listed above, you can select the digital input only for the sources which you have selected the digital input terminals for. (See "Digital Input (DIGITAL IN) Terminal Setting" on page 19.)

2. Press ANALOG/DIGITAL INPUT to change the input mode.



- Each time you press the button, the input mode changes as follows:

DGTL AUTO (Digital) ↔ ANALOG

When playing a software encoded with the Dolby Digital or DTS Digital Surround, "DGTL AUTO" may not happen to work well. In this case press CONTROL UP ▲/DOWN ▼ on the front panel to select "DGTL D.D" or "DGTL DTS" (while "DGTL AUTO" remains on the display).

Note:

You can select "DGTL D.D" or "DGTL DTS" from the remote control by using the On-Screen Menus (see page 36).

Showing the Text Information on the Display

When you have connected an MD recorder or CD player equipped with TEXT COMPU LINK remote control system (see page 42), you can show the text information, such as disc title or track title, on the display of this receiver. To show it on the display, follow the procedure below.

Before you start, remember....

- There is a time limit in doing the following steps. If the setting is canceled before you finish, start from step 1 again.

On the front panel ONLY:

1. Press **SETTING** repeatedly until “**FL DISP**” (Display) appears on the display.

The display changes to show the current setting.

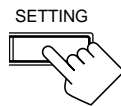

2. Press **CONTROL UP ▲/DOWN ▼** to select either the source name or the text information to be shown on the display.

- Each time you press the button, the display changes to show the following:

NORM (Normal) ←→ TEXT

NORM:	Source name and Surround/DSP mode appear during play.
TEXT:	Text information appears during play.

Note:

Though you have selected “TEXT,” the source name and Surround / DSP mode appear if a playing disc has no text information.

Basic Setting and Adjustment — Auto Memory

Without any setting required, this receiver stores different sound settings for each different playing source automatically whenever you do the following:

- Turning on the power (see page 11)
- Changing the source to play (see page 11)
- Changing the source name (see page 16)

So, you do not have to change the sound settings next time you select the same source. The stored settings for the selected source are automatically recalled.

The following settings are automatically stored for each source:

- Front speaker output balance (see page 16)
- Subwoofer setting and its output level (see page 17)
- Input attenuator mode (see page 14)
- Midnight mode (see page 13)
- Bass boost (see page 14)
- Digital equalization adjustment (see page 15)
- Line direct (see page 14)
- Surround mode on/off (see page 26)
- Surround/DSP mode setting (see pages 27 – 34)
- DVD MULTI playback mode setting (see page 35)
- Analog/digital input mode (see page 20)

You can assign and store the volume level for each source. See below.

Notes:

- If the source is FM or AM, you can assign different settings for each band.
- You cannot assign and store different settings for each digital input mode.
- The Surround modes and DSP modes cannot be used with DVD MULTI playback mode at the same time.

To store the volume level

Before you start, remember....

- There is a time limit in doing the following steps. If the setting is canceled before you finish, start from step 1 again.

On the front panel ONLY:

1. Press **SETTING** repeatedly until “**ONE TOUCH**” appears on the display.

The display changes to show the current setting.

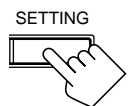

2. Press **CONTROL UP ▲/DOWN ▼** to turn on the One Touch Operation.

The ONE TOUCH OPERATION indicator lights up on the display.

- Each time you press the button, the one touch operation function turns on (“ON”) and off (“OFF”).

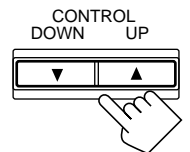

To recall the volume level

With the ONE TOUCH OPERATION indicator lit, the volume level for the currently selected source is recalled when the source is selected.

To cancel the One Touch Operation

Select “OFF” in step 2 above so that the ONE TOUCH OPERATION indicator goes off. (Even though the One Touch Operation is canceled, the recalled volume remains active.)

Receiving Radio Broadcasts

You can browse through all the stations or use the preset function to go immediately to a particular station.

Setting the AM Tuner Interval Spacing

Some countries space AM stations 9 kHz apart, and other countries use 10 kHz spacing.

On the front panel ONLY:

To select the 10 kHz interval:

Be sure the receiver is turned off, but is plugged into an AC outlet. Hold down FM/AM TUNING ▲ and press STANDBY/ON ⏻. Now the 10 kHz interval is selected.

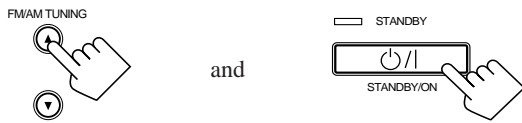

To change back to the 9 kHz interval:

Be sure the receiver is turned off, but is plugged into an AC outlet. Hold down FM/AM TUNING ▼ and press STANDBY/ON ⏻. Now the 9 kHz interval is selected.

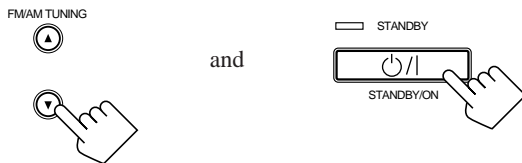

Tuning in Stations Manually

On the front panel:

1. Press FM/AM to select the band (FM or AM).

The FM/AM lamp on the front panel button lights up. The last received station of the selected band is tuned in.

- Each time you press the button, the band alternates between FM and AM.

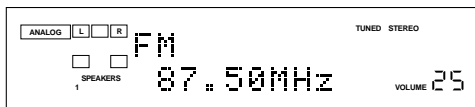

2. Press FM/AM TUNING ▲/▼ until you find the frequency you want.

- Pressing FM/AM TUNING ▲ increases the frequency.
- Pressing FM/AM TUNING ▼ decreases the frequency.



From the remote control:

1. Press FM/AM to select the band (FM or AM).

The FM/AM lamp on the front panel button lights up. The last received station of the selected band is tuned in.

- Each time you press the button, the band alternates between FM and AM.



2. Press TUNING UP ► or TUNING DOWN ◀ until you find the frequency you want.

- Pressing TUNING UP ► increases the frequency.
- Pressing TUNING DOWN ◀ decreases the frequency.

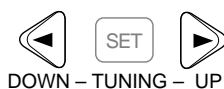

Notes:

- When a station of sufficient signal strength is tuned in, the TUNED indicator lights up on the display.
- When an FM stereo program is received, the STEREO indicator also lights up.
- When you hold the button (and release it) in step 2, the frequency keeps changing until a station is tuned in.

Using Preset Tuning

Once a station is assigned to a channel number, the station can be quickly tuned. You can preset up to 30 FM and 15 AM stations.

To store the preset stations

Before you start, remember..

- There is a time limit in doing the following steps. If the setting is canceled before you finish, start from step 1 again.

On the front panel ONLY:

1. Tune in the station you want to preset (see “Tuning in Stations Manually” on the left).

- If you want to store the FM reception mode for this station, select the FM reception mode you want. See “Selecting the FM Reception Mode” on page 23.

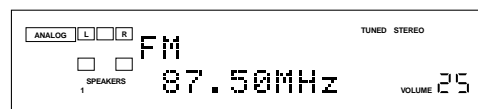

2. Press MEMORY.



The channel number position starts flashing on the display for about 10 seconds.

3. Press FM/AM PRESET ▲/▼ to select a channel number while the channel number position is flashing.



4. Press MEMORY again while the selected channel number is flashing on the display.

The selected channel number stops flashing. The station is assigned to the selected channel number.

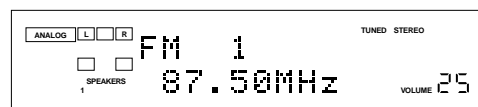

5. Repeat steps 1 to 4 until you store all the stations you want.

To erase a stored preset station

Storing a new station on a used number erases the previously stored one.

To tune in a preset station

On the front panel:

1. Press FM/AM to select the band (FM or AM).

The FM/AM lamp on the front panel button lights up. The last received station of the selected band is tuned in.

- Each time you press the button, the band alternates between FM and AM.

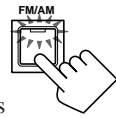

2. Press FM/AM PRESET ▲/▼ until you find the channel you want.

- Pressing FM/AM PRESET ▲ increases the number.
- Pressing FM/AM PRESET ▼ decreases the number.



From the remote control:

1. Press FM/AM.

The last received station of the selected band is tuned in.

- Each time you press the button, the band alternates between FM and AM.

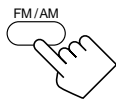

2. Press the 10 keys to select a preset channel number.

- For channel number 5, press 5.
- For channel number 15, press +10 then 5.
- For channel number 20, press +10 then 10.
- For channel number 30, press +10, +10, then 10.

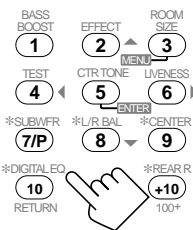

Note:

When you use the 10 keys on the remote control, be sure that they are activated for the tuner, not for the CD and others. (See page 11.)

Selecting the FM Reception Mode

When an FM stereo broadcast is hard to receive or noisy

You can change the FM reception mode while receiving an FM broadcast.

- You can store the FM reception mode for each preset station.

Press FM MODE.

- Each time you press the button, the FM reception mode alternates between "AUTOMUTING" and "MONO."



On the front panel



From the remote control

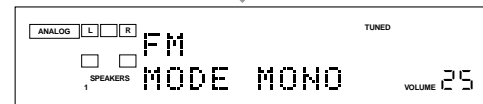

AUTOMUTING: When a program is broadcasted in stereo, you will hear stereo sound; when in monaural, you will hear monaural sounds. This mode is also useful to suppress static noise between stations. The AUTO MUTING indicator lights up on the display.

MONO: Reception will be improved although you will lose the stereo effect. In this mode, you will hear noise while tuning into the stations. The AUTO MUTING indicator goes off from the display.

Note:

When using the FM MODE on the remote control, be sure that the 10 keys are activated for the tuner, not for the CD and others. (See page 11.)

Creating a Surround Field in Your Room

The built-in Surround Processor provides Surround mode and four types of the DSP (Digital Signal Processor) mode — DAP (Digital Acoustic Processor) mode, 5 CH/4 CH Stereo mode, 3D-PHONIC mode, and HEADPHONE DSP mode. With this receiver, you can use a Surround mode and a DSP mode at the same time. Once you have adjusted Surround and/or DSP modes, the adjustments done for each source are memorized.

Surround modes

With this receiver, you can use two types of the Surround mode. **Following modes cannot be used when only the front speakers are connected to this receiver (without the rear speakers or center speaker).**

Dolby Surround (Dolby Digital and Dolby Pro Logic)*

Used to watch the soundtracks of software encoded with Dolby Digital (bearing the mark ) or with Dolby Surround (bearing the mark .

Dolby Surround encoding format records the left front channel, right front channel, center channel, and rear channel (total 4 channels) signals into 2 channels. The Dolby Pro Logic decoder built in this receiver decodes these 2 channel signals into original 4 channel signals — matrix-based multichannel reproduction, and allows you to enjoy the realistic sound field in your listening room.

On the other hand, Dolby Digital encoding method (so called a discrete 5.1 channel digital audio format) records and compresses the left front channel, right front channel, center channel, left rear channel, right rear channel, and LFE channel (total 6 channels, but LFE channel is counted as 0.1 channel, therefore called 5.1 channels) signals digitally. Each channel is completely independent from other channel signals to avoid interference, therefore, you can obtain much better sound quality with much stereo and surround effects.

The Dolby Digital decoder built in this receiver can create much more realistic sound field in your listening room. You may feel as if you were in a real theater.

In addition, Dolby Digital enables stereo rear sounds, and sets the cutoff frequency of the rear treble at 20 kHz, comparing to 7 kHz for Dolby Pro Logic. These facts enhance the sound movement and being-there feelings much more than Dolby Pro Logic.

- To enjoy the software encoded with Dolby Digital, you must connect the source component using the digital terminal on the rear of this receiver. (See page 8.)

DTS Digital Surround**

DTS Digital Surround is another discrete 5.1 channel digital audio format available on CD, LD, and DVD software encoded with DTS Digital Surround (bearing the mark .

Comparing to Dolby Digital, audio compression rate is relatively low. This fact allows DTS Digital Surround format to add breadth and depth to the reproduced sounds. As a result, DTS Digital Surround features natural, solid and clear sound.

- To enjoy the software encoded with DTS Digital Surround, you must connect the source component using the digital terminal on the rear of this receiver. (See page 8.)

DSP modes

With this receiver, you can use four types of the DSP mode.

DAP modes

In order to reproduce a more acoustic sound field in your listening room while playing music sources, you can use DAP modes. **This mode can be used when the front speakers are connected to this receiver (without respect to the rear/center speaker connection).**

THEATER 1:	Reproduces the sound field of a large theater (where the seating capacity about 1,000).
THEATER 2:	Reproduces the sound field of a small theater (where the seating capacity about 300).
HALL 1:	Gives clear vocal and the feeling of a large concert hall (where the seating capacity about 1,000).
HALL 2:	Gives clear vocal and the feeling of a small concert hall (where the seating capacity about 300).
LIVE CLUB:	Gives the feeling of a live music club with a low ceiling.
DANCE CLUB:	Gives a throbbing bass beat.
PAVILION:	Gives the spacious feeling of a pavilion with a high ceiling.

5 CH/4 CH Stereo mode

You can create more powerful sound field for both of the digital and analog stereo sounds source. The 4 CH Stereo mode reproduces a sound field through the front left and right speakers and rear left and right speakers. The 5 CH Stereo mode adds the center channel element to the 4 CH Stereo sound field by outputting mixed left and right signals through the center speaker. **This mode cannot be used when only the front speakers are connected to this receiver without the rear speakers.**

Note:

"5CH STEREO" is selected when setting the center speaker to "LARGE" or "SMALL," and "4CH STEREO" is selected when setting the center speaker to "NONE" (see page 17).

* Manufactured under license from Dolby Laboratories. "Dolby," "Pro Logic," and the double-D symbol are trademarks of Dolby Laboratories. Confidential Unpublished Works. ©1992–1997 Dolby Laboratories, Inc. All rights reserved.

** Manufactured under license from Digital Theater Systems, Inc. US Pat. No. 5,451,942 and other world-wide patents issues and pending. "DTS" and "DTS Digital Surround" are trademarks of Digital Theater Systems, Inc. ©1996 Digital Theater Systems, Inc. All rights reserved.

3D-PHONIC modes

The 3D-PHONIC mode gives you such a nearly surround effect as is reproduced through the Dolby Surround decoder, which is widely used to reproduce sounds with a feeling of movement like those experienced in movie theaters. The 3D-PHONIC mode is the result of research on sound localization technology carried out at JVC for many years. **This mode can be used when the front speakers are connected to this receiver (without respect to the rear/center speaker connection).** When the 3D-PHONIC mode is reproduced with the center speaker connected, you can feel as if actors on the screen actually speak in your room.

- You can select “3D ACTION” only when playing an analog or linear PCM (digital) source.
- You can select “3D DIGITAL” only when playing a source encoded with Dolby Digital or DTS Digital Surround.

3D ACTION: Best for action and war movies — where the action is fast and explosive.

3D DIGITAL: Reproduces multichannel source encoded with Dolby Digital or with DTS Digital Surround.

HEADPHONE DSP mode

The HEADPHONE DSP mode can create the stereo sound as if you listen through the speakers while listening to a source using headphones. So you can feel as if you were in a music room. **This mode can be used only when both of the front speakers are deactivated (see page 13.)**

Notes:

- When you select “DVD MULTI” as the source to play, you cannot select or adjust the Surround and DSP modes.
- The PRO LOGIC indicator lights up when the Dolby Pro Logic decoder built in this receiver is activated.
- When the line direct function is turned on, the Surround and DSP modes are canceled temporarily (see page 14).
- No adjustment can be made for the HEADPHONE DSP mode.

Reproducing the Sound Field

The sound heard in a concert hall or club consists of direct sound and indirect sound — early reflections and reflections from behind. Direct sounds reach the listener directly without any reflection. On the other hand, indirect sounds are delayed by the distances of the ceiling and walls. These direct sounds and indirect sounds are the most important elements of the acoustic surround effects. The Surround and DSP modes can create these important elements, and give you a real “being there” feeling.

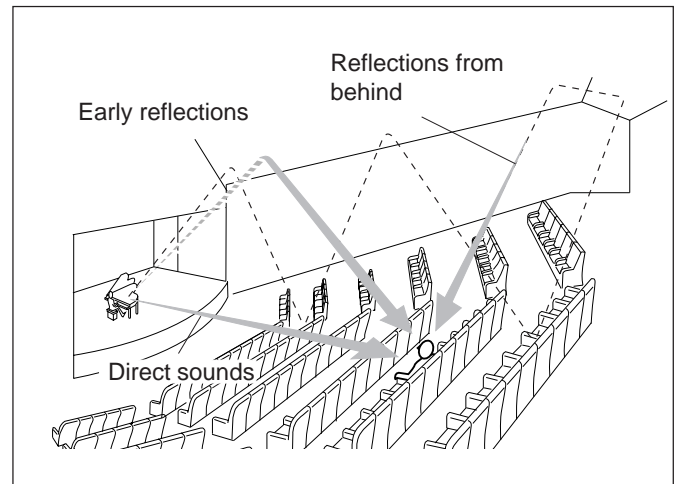

DVD MULTI Playback Mode

This receiver provides the DVD MULTI playback mode for reproducing the analog discrete 5.1 channel output mode of the DVD player or other equipment.

You can adjust the DVD MULTI playback mode while playing back a video software such as a DVD using the analog discrete 5.1 channel output mode.

- For the DVD MULTI playback mode connection, see page 7.
- For details on the DVD MULTI playback mode, see page 35.

DSP Modes Available to Input Mode

○: Possible / ×: Impossible

MODE INPUT SIGNAL	SURROUND	D S P			SURROUND with DAP	SURRE. OFF DSP OFF	HEADPHOHE	
		DAP MODE	3D ACTION (DIGITAL)	5 CH/4 CH Stereo			HEADPHONE DSP	HEADPHONE
ANALOG (2 CH)	○ (DOLBY PRO LOGIC)	○	○ (3D ACTION)	○	○	○	○	○
DVD MULTI (5.1 CH)	×	×	×	×	×	×	×	○
LINEAR PCM	○ (DOLBY PRO LOGIC)	○	○ (3D ACTION)	○	○	○	○	○
DOLBY DIGITAL	○ ¹ (DOLBY DIGITAL)	○	○ (3D DIGITAL)	○	○	○	○	○
DTS	○ ² (DTS SURROUND)	○	○ (3D DIGITAL)	○	○	○	○	○

¹ When 2 channel signal comes in, DOLBY PRO LOGIC is selected. When other signals come in, DOLBY DIGITAL is selected.

² When 2 channel signal comes in, DOLBY PRO LOGIC is selected. When other signals come in, DTS SURROUND is selected.

Available DSP Modes According to the Speaker Arrangement

Available DSP modes will vary depending on how many speakers are used with this receiver.

Make sure that you have set the speaker information correctly (see page 17).

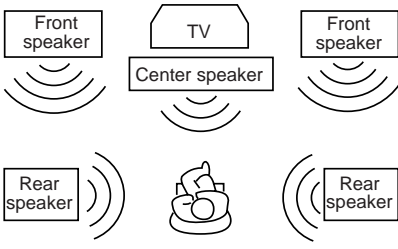
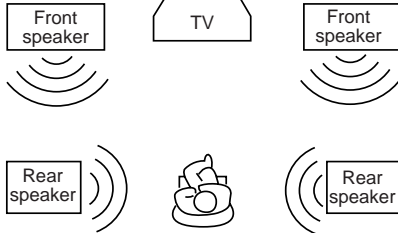
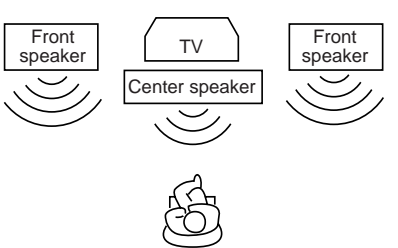
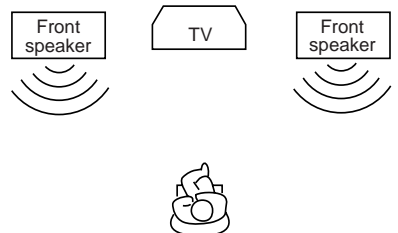
Speaker arrangements	Available DSP modes
	<p>Each time you press DSP MODE, the DSP modes change as follows:</p> <p>THEATER 1 → THEATER 2 → HALL 1 → HALL 2 → LIVE CLUB → DANCE CLUB → PAVILION → 5CH STEREO (when using 5 speakers) or 4CH STEREO (when using 4 speakers)* → 3D ACTION or 3D DIGITAL → SURR. OFF (DSP OFF) → (Back to the beginning)</p> <div style="border: 1px solid black; padding: 5px; margin-top: 10px;"> <p>To activate the Surround mode, press SURROUND ON/OFF button so that the SURROUND ON/OFF lamp on the front panel button lights up.</p> </div> <p>Notes:</p> <ul style="list-style-type: none"> If the settings for the center and the rear speakers are changed to "NONE" (see page 17), the Surround mode will be canceled. When both of the Surround mode and DSP mode are deactivated, "SURR. OFF" appears on the display. <p>* "5CH STEREO" is selected when setting the center speaker to "LARGE" or "SMALL," and "4CH STEREO" is selected when setting the center speaker to "NONE" (see page 17).</p>
	<p>THEATER 1 → THEATER 2 → HALL 1 → HALL 2 → LIVE CLUB → DANCE CLUB → PAVILION → 3D ACTION or 3D DIGITAL → SURR. OFF (DSP OFF) → (Back to the beginning)</p> <div style="border: 1px solid black; padding: 5px; margin-top: 10px;"> <p>To activate the Surround mode, press SURROUND ON/OFF button so that the SURROUND ON/OFF lamp on the front panel button lights up.</p> </div> <p>Notes:</p> <ul style="list-style-type: none"> If the setting for the center speaker is changed to "NONE" (see page 17), the Surround mode will be canceled. When both of the Surround mode and DSP mode are deactivated, "SURR. OFF" appears on the display.
	<p>THEATER 1 → THEATER 2 → HALL 1 → HALL 2 → LIVE CLUB → DANCE CLUB → PAVILION → 3D ACTION or 3D DIGITAL → SURR. OFF (DSP OFF) → (Back to the beginning)</p> <p>Note:</p> <p>Surround mode cannot be used when only the front speakers are connected.</p>
	<p>HEADPHONE ↔ HEADPHONE DSP</p> <p>Note:</p> <p>To use the HEADPHONE or HEADPHONE DSP mode, deactivate both of the front speakers (see page 13).</p>

Adjusting the Surround Modes



You can also use a Surround mode with a DAP mode (see page 30).

Before you start, remember...

- Make sure that you have set the speaker information correctly (see page 17).
- There is a time limit in doing the following steps. If the setting is canceled before you finish, start from step 3 again.
- You cannot adjust the rear speaker output levels when you have set "REAR SPK" to "NONE." See page 17.
- You cannot adjust the center speaker output level and center tone when you have set "CTR SPK" to "NONE." See page 17.
- To adjust the front speaker output balance and subwoofer output level, see pages 16 and 17.

From the remote control:

1. Select and play a sound source.

- To enjoy Dolby Pro Logic, play back a software encoded with Dolby Surround and labeled with  mark.
- To enjoy Dolby Digital, play back a software encoded with Dolby Digital and labeled with  mark.
- To enjoy DTS Digital Surround, play back a software encoded with DTS Digital Surround and labeled with  mark.

2. Press SURROUND ON/OFF to activate an appropriate Surround mode — PRO LOGIC, DOLBY DIGITAL or DTS SURROUND.



The SURROUND ON/OFF lamp on the front panel button lights up.

- Each time you press the button, the Surround mode turns on and off alternately.
- When "PRO LOGIC" is selected, the PRO LOGIC indicator lights up on the display.

3. Press SOUND.

The 10 keys are activated for sound adjustments.

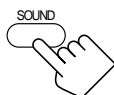

4. Press TEST to check the speaker output balance.

"TEST TONE L" starts flashing on the display, and a test tone comes out of the speakers in the following order:

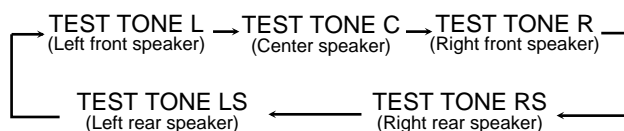

Notes:

- You can adjust the speaker output levels without outputting the test tone.
- No test tone comes out of the center speaker when "CTR SPK" is set to "NONE" (see page 17).
- No test tone comes out of the rear speakers when "REAR SPK" is set to "NONE" (see page 17).
- If the TV is turned on and the proper video input is selected on the TV, the test tone screen will appear on the TV.

5. Select the speaker you want to adjust.

- To select the center speaker level, press CENTER. "CTR" appears on the remote control display window.
- To select the left rear speaker level, press REAR L. "REARL" appears on the remote control display window.
- To select the right rear speaker level, press REAR R. "REARR" appears on the remote control display window.



6. Press LEVEL +/- to adjust the speaker output levels (-10 dB to +10 dB).

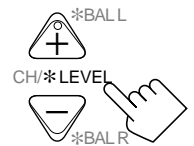

7. Press SOUND.

- To adjust other speaker output levels, repeat steps 5 and 6.

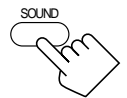

8. Press TEST again to stop the test tone.



9. Press CTR TONE to select the center tone level you want.



The center tone adjustment affects the mid-frequency range, which the human voice is mostly made up of.

- Each time you press the button, the display changes to show the following:

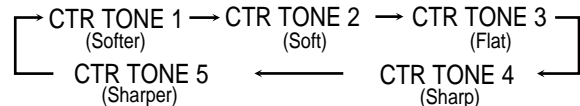

To make the dialogue softer, select "CTR TONE 1" or "CTR TONE 2."



To make the dialogue clearer, select "CTR TONE 4" or "CTR TONE 5."

When "CTR TONE 3" is selected, no adjustment is applied.

On the front panel:

You can also use the buttons on the front panel to adjust the Surround modes. However, no test tone is available when using the buttons on the front panel. So, make adjustments while listening to the sound of the source played back.

1. Select and play a sound source.

- To enjoy Dolby Pro Logic, play back a software encoded with Dolby Surround and labeled with  mark.
- To enjoy Dolby Digital, play back a software encoded with Dolby Digital and labeled with  mark.
- To enjoy DTS Digital Surround, play back a software encoded with DTS Digital Surround and labeled with  mark.

2. Press SURROUND ON/OFF to activate an appropriate Surround mode — PRO LOGIC, DOLBY DIGITAL or DTS SURROUND.

SURROUND ON/OFF

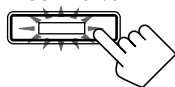

The SURROUND ON/OFF lamp on the front panel button lights up.

- Each time you press the button, the Surround mode turns on and off alternately.
- When “PRO LOGIC” is selected, the PRO LOGIC indicator lights up on the display.

3. Adjust the speaker output levels.

1) Press LEVEL ADJUST repeatedly until one of the following indications appears on the display.

“CENTER”:

To adjust the center speaker level.

“REAR L”:

To adjust the left rear speaker level.

“REAR R”:

To adjust the right rear speaker level.

2) Press CONTROL UP ▲/DOWN ▼ to adjust the selected speaker output level (from -10 dB to +10 dB).

3) Repeat 1) and 2) to adjust the other speaker output levels.

LEVEL ADJUST

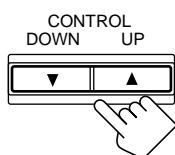

4. Adjust the center tone.

1) Press EFFECT repeatedly until “CTR TONE” appears on the display.

The display shows the current setting.

2) Press CONTROL UP ▲/DOWN ▼ to select the center tone level you want.

- Each time you press the button, the display changes to show the following:

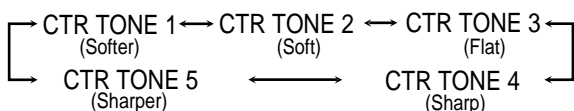

To make the dialogue softer, select “CTR TONE 1” or “CTR TONE 2.”

To make the dialogue clearer, select “CTR TONE 4” or “CTR TONE 5.”

When “CTR TONE 3” is selected, no adjustment is applied.

EFFECT

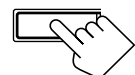

CONTROL UP

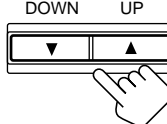

On the front panel:

1. Press DSP MODE repeatedly until the DAP mode you want to adjust — THEATER 1, THEATER 2, HALL 1, HALL 2, LIVE CLUB, DANCE CLUB, or PAVILION — appears on the display.

DSP MODE

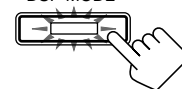

The DSP MODE lamp on the front panel button lights up, and the DSP indicator also lights up on the display.

- When you have set “REAR SPK” to “NONE,” the 3D-PHONIC indicator also lights up.

2. Adjust the speaker output levels.

1) Press LEVEL ADJUST repeatedly until one of the following indications appears on the display.

“CENTER”:

To adjust the center speaker level.

“REAR L”:

To adjust the left rear speaker level.

“REAR R”:

To adjust the right rear speaker level.

2) Press CONTROL UP ▲/DOWN ▼ to adjust the selected speaker output level (from -10 dB to +10 dB).

3) Repeat 1) and 2) to adjust the other speaker output levels.

LEVEL ADJUST

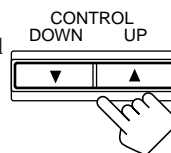

3. Adjust the center tone.

1) Press EFFECT repeatedly until “CTR TONE” appears on the display.

The display shows the current setting.

2) Press CONTROL UP ▲/DOWN ▼ to select the center tone level you want.

The center tone adjustment affects the mid-frequency range, which the human voice is mostly made up of.

- Each time you press the button, the display changes to show the following:

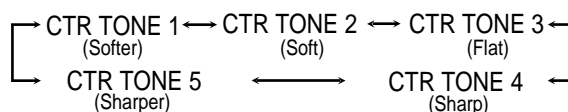

To make the dialogue softer, select “CTR TONE 1” or “CTR TONE 2.”

To make the dialogue clearer, select “CTR TONE 4” or “CTR TONE 5.”

When “CTR TONE 3” is selected, no adjustment is applied.

EFFECT

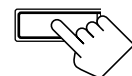

CONTROL UP

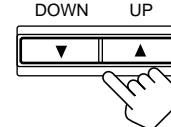

Adjusting the DAP Modes

You can also use a DAP mode with a Surround mode (see page 30).

Before you start, remember...

- Make sure that you have set the speaker information correctly (see page 17).
- There is a time limit in doing the following steps. If the setting is canceled before you finish, start from step 2 again.
- You cannot adjust the rear speaker output level when you have set “REAR SPK” to “NONE.” See page 17.
- You cannot adjust the center speaker output level when you have set “CTR SPK” to “NONE.” See page 17.
- To adjust the front speaker output balance and subwoofer output level, see pages 16 and 17.

Continued to the next page.

4. Adjust the overall levels of the effect.

- 1) Press **EFFECT** repeatedly until “EFFECT” appears on the display.

The display shows the current setting.

- 2) Press **CONTROL UP ▲/DOWN ▼** to select the effect level you want.

• Each time you press the button, the display changes to show the following:

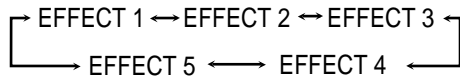

As the number increases, the selected DAP effect becomes stronger. (Normally set it to “EFFECT 3.”)

5. Adjust the room size (sense of spaciousness).

- 1) Press **EFFECT** repeatedly until “ROOMSIZE” appears on the display.

The display shows the current setting.

- 2) Press **CONTROL UP ▲/DOWN ▼** to select the room size you want.

• Each time you press the button, the display changes to show the following:

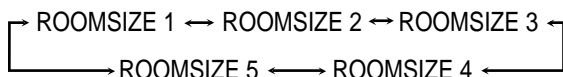

As the number increases, the interval between reflections increases so that you will feel as if you were in a larger room. (Normally set it to “ROOMSIZE 3.”)

6. Adjust the liveness.

- 1) Press **EFFECT** repeatedly until “LIVENESS” appears on the display.

The display shows the current setting.

- 2) Press **CONTROL UP ▲/DOWN ▼** to select the liveness level you want.

• Each time you press the button, the display changes to show the following:

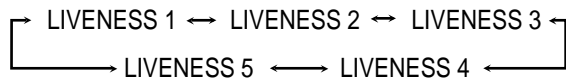

As the number increases, the attenuation level of reflections over time decreases so that acoustics change from “Dead” to “Live.” (Normally set it to “LIVENESS 3.”)

From the remote control:

1. Press **DSP MODE** repeatedly until the DAP mode you want to adjust — **THEATER 1, THEATER 2, HALL 1, HALL 2, LIVE CLUB, DANCE CLUB, or PAVILION** — appears on the display.

The DSP MODE lamp on the front panel button lights up, and the DSP indicator also lights up on the display.

• When you have set “REAR SPK” to “NONE,” the 3D-PHONIC indicator also lights up.

2. Press **SOUND**.

The 10 keys are activated for sound adjustments.

3. Select the speaker you want to adjust.

- To select the center speaker level, press **CENTER**. “CTR” appears on the remote control display window.
- To select the left rear speaker level, press **REAR L**. “REARL” appears on the remote control display window.
- To select the right rear speaker level, press **REAR R**. “REARR” appears on the remote control display window.



4. Press **LEVEL +/-** to adjust the speaker output levels (–10 dB to +10 dB).

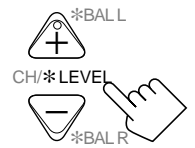

5. Press **SOUND**.

- To adjust other speaker output levels, repeat steps 3 and 4.

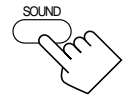

6. Press **CTR TONE** to select the center tone level you want.

- Each time you press the button, the display changes to show the following:

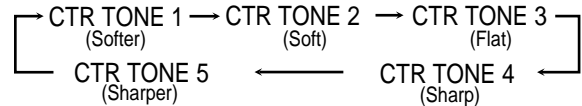

To make the dialogue softer, select “CTR TONE 1” or “CTR TONE 2.”

To make the dialogue clearer, select “CTR TONE 4” or “CTR TONE 5.”

When “CTR TONE 3” is selected, no adjustment is applied.

7. Press **EFFECT** to adjust the overall level of the effect.

- Each time you press the button, the effect level changes as follows:

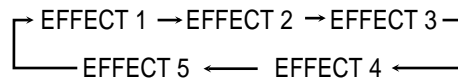

As the number increases, the selected DAP effect becomes stronger. (Normally set it to “EFFECT 3.”)

8. Press **ROOM SIZE** to adjust the room size (sense of spaciousness).

- Each time you press the button, the room size changes as follows:

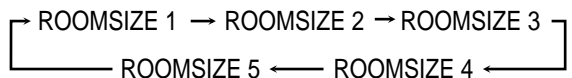

As the number increases, the interval between reflections increases so that you will feel as if you were in a larger room. (Normally set it to “ROOMSIZE 3.”)

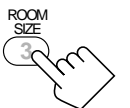

9. Press LIVENESS to adjust the liveness.

- Each time you press the button, the liveness changes as follows:

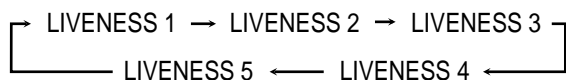

As the number increases, the attenuation level of reflections over time decreases so that acoustics change from “Dead” to “Live.” (Normally set it to “LIVENESS 3.”)

Adjusting the Surround Modes with the DAP Modes

Before you start, remember...

- Make sure that you have set the speaker information correctly (see page 17).
- There is a time limit in doing the following steps. If the setting is canceled before you finish, start from step 4 again.
- You cannot adjust the rear speaker output levels when you have set “REAR SPK” to “NONE.” See page 17.
- You cannot adjust the center speaker output level and center tone when you have set “CTR SPK” to “NONE.” See page 17.
- To adjust the front speaker output balance and subwoofer output level, see pages 16 and 17.

From the remote control:

1. Select and play a sound source.

- To enjoy Dolby Pro Logic, play back a software encoded with Dolby Surround and labeled with mark.
- To enjoy Dolby Digital, play back a software encoded with Dolby Digital and labeled with mark.
- To enjoy DTS Digital Surround, play back a software encoded with DTS Digital Surround and labeled with mark.

2. Press SURROUND ON/OFF to activate an appropriate Surround mode — PRO LOGIC, DOLBY DIGITAL or DTS SURROUND.



The SURROUND ON/OFF lamp on the front panel button lights up.

- Each time you press the button, the Surround mode turns on and off alternately.
- When “PRO LOGIC” is selected, the PRO LOGIC indicator lights up on the display.

3. Press DSP MODE repeatedly until the DAP mode you want to adjust — THEATER 1, THEATER 2, HALL 1, HALL 2, LIVE CLUB, DANCE CLUB, or PAVILION — appears on the display.

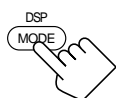

The DSP MODE lamp on the front panel button lights up, and the DSP indicator also lights up on the display.

4. Press SOUND.

The 10 keys are activated for sound adjustments.

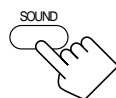

5. Press TEST to check the speaker output balance.



“TEST TONE L” starts flashing on the display, and a test tone comes out of the speakers in the following order:

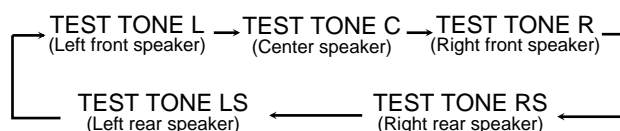

Notes:

- You can adjust the speaker output levels without outputting the test tone.
- No test tone comes out of the center speaker when “CTR SPK” is set to “NONE” (see page 17).
- No test tone comes out of the rear speakers when “REAR SPK” is set to “NONE” (see page 17).
- If the TV is turned on and the proper video input is selected on the TV, the test tone screen will appear on the TV.

6. Select the speaker you want to adjust.

- To select the center speaker level, press CENTER. “CTR” appears on the remote control display window.
- To select the left rear speaker level, press REAR L. “REARL” appears on the remote control display window.
- To select the right rear speaker level, press REAR R. “REARR” appears on the remote control display window.



7. Press LEVEL +/- to adjust the speaker output levels (–10 dB to +10 dB).



8. Press SOUND.

- To adjust other speaker output levels repeat steps 6 and 7.

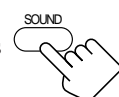

9. Press TEST again to stop the test tone.



10. Press CTR TONE to select the center tone level you want.

The center tone adjustment affects the mid-frequency range, which the human voice is mostly made up of.

- Each time you press the button, the display changes to show the following:

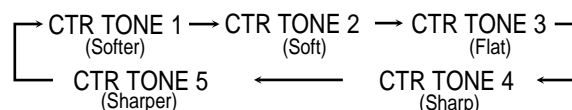

To make the dialogue softer, select “CTR TONE 1” or “CTR TONE 2.”

To make the dialogue clearer, select “CTR TONE 4” or “CTR TONE 5.”

When “CTR TONE 3” is selected, no adjustment is applied.

Continued to the next page.

11. Press EFFECT to adjust the overall level of the effect.

- Each time you press the button, the effect level changes as follows:

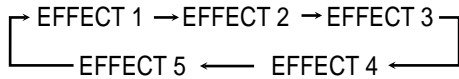

As the number increases, DAP effect becomes stronger.
(Normally set it to "EFFECT 3.")



12. Press ROOM SIZE to adjust the room size (sense of spaciousness).

- Each time you press the button, the room size changes as follows:

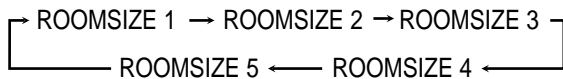

As the number increases, the interval between reflections increases so that you will feel as if you were in a larger room.
(Normally set it to "ROOMSIZE 3.")



13. Press LIVENESS to adjust the liveness.

- Each time you press the button, the liveness changes as follows:

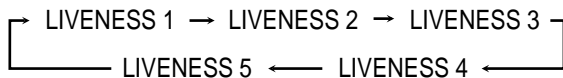

As the number increases, the attenuation level of reflections over time decreases so that acoustics change from "Dead" to "Live."
(Normally set it to "LIVENESS 3.")



On the front panel:

You can also use the buttons on the front panel to adjust the sound with a Surround mode and a DAP mode. However, no test tone is available when using the buttons on the front panel. So, make adjustments while listening to the sound of the source played back.

1. Select and play a sound source.

- To enjoy Dolby Pro Logic, play back a software encoded with Dolby Surround and labeled with mark.
- To enjoy Dolby Digital, play back a software encoded with Dolby Digital and labeled with mark.
- To enjoy DTS Digital Surround, play back a software encoded with DTS Digital Surround and labeled with mark.

2. Press SURROUND ON/OFF to activate an appropriate Surround mode — PRO LOGIC, DOLBY DIGITAL or DTS SURROUND.

The SURROUND ON/OFF lamp on the front panel button lights up.

- Each time you press the button, the Surround mode turns on and off alternately.
- When "PRO LOGIC" is selected, the PRO LOGIC indicator lights up on the display.

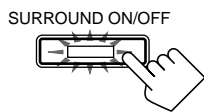

3. Press DSP MODE repeatedly until the DAP mode you want to adjust — THEATER 1, THEATER 2, HALL 1, HALL 2, LIVE CLUB, DANCE CLUB, or PAVILION — appears on the display.

The DSP MODE lamp on the front panel button lights up, and the DSP indicator also lights up on the display.

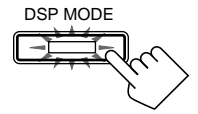

4. Adjust the speaker output levels.

- Press LEVEL ADJUST repeatedly until one of the following indications appears on the display.

"CENTER":

To adjust the center speaker level.

"REAR L":

To adjust the left rear speaker level.

"REAR R":

To adjust the right rear speaker level.



- Press CONTROL UP ▲/DOWN ▼ to adjust the selected speaker output level (from -10 dB to +10 dB).

- Repeat 1) and 2) to adjust the other speaker output levels.

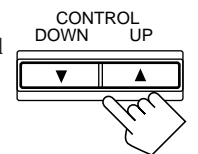

5. Adjust the center tone.

- Press EFFECT repeatedly until "CTR TONE" appears on the display.

The display shows the current setting.

- Press CONTROL UP ▲/DOWN ▼ to select the center tone level you want.

- Each time you press the button, the display changes to show the following:

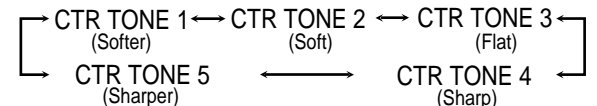

To make the dialogue softer, select "CTR TONE 1" or "CTR TONE 2."

To make the dialogue clearer, select "CTR TONE 4" or "CTR TONE 5."

When "CTR TONE 3" is selected, no adjustment is applied.

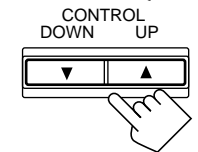
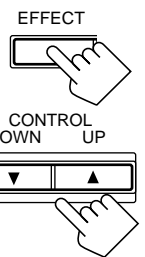

6. Adjust the overall levels of the effect.

- Press EFFECT repeatedly until "EFFECT" appears on the display.

The display shows the current setting.

- Press CONTROL UP ▲/DOWN ▼ to select the effect level you want.

- Each time you press the button, the display changes to show the following:

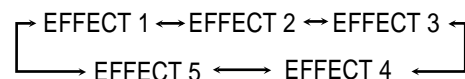

As the number increases, DAP effect becomes stronger.
(Normally set it to "EFFECT 3.")

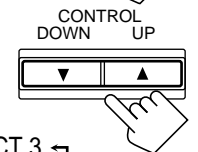
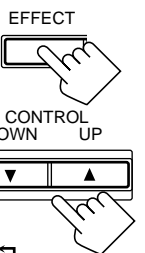

7. Adjust the room size (sense of spaciousness).

- 1) Press **EFFECT** repeatedly until **"ROOMSIZE"** appears on the display.

The display shows the current setting.

- 2) Press **CONTROL UP ▲/DOWN ▼** to select the room size you want.

• Each time you press the button, the display changes to show the following:

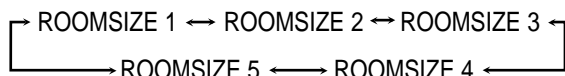

As the number increases, the interval between reflections increases so that you will feel as if you were in a larger room. (Normally set it to "ROOMSIZE 3.")

8. Adjust the liveness.

- 1) Press **EFFECT** repeatedly until **"LIVENESS"** appears on the display.

The display shows the current setting.

- 2) Press **CONTROL UP ▲/DOWN ▼** to select the liveness level you want.

• Each time you press the button, the display changes to show the following:

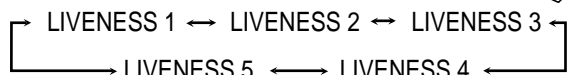

As the number increases, the attenuation level of reflections over time decreases so that acoustics change from "Dead" to "Live." (Normally set it to "LIVENESS 3.")

Adjusting the 5 CH/4 CH Stereo Mode

Before you start, remember...

- Make sure that you have set the speaker information correctly (see page 17).
- There is a time limit in doing the following steps. If the setting is canceled before you finish, start from step 2 again.
- You cannot adjust the center speaker output level and select the center tone level for 4 CH Stereo mode.
- To adjust the front speaker output balance and subwoofer output level, see pages 16 and 17.

On the front panel:

1. Press **DSP MODE** repeatedly until **"5CH STEREO"** or **"4CH STEREO"** appears on the display.

The DSP MODE lamp on the front panel button lights up, and the DSP indicator also lights up on the display.

- "4CH STEREO" appears on the display when you have set "CTR SPK" to "NONE" (see page 17).

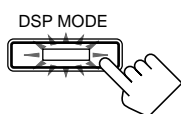

2. Adjust the speaker output levels.

- 1) Press **LEVEL ADJUST** repeatedly until one of the following indications appears on the display.

"CENTER" — for 5 CH Stereo mode only:

To adjust the center speaker level.

"REAR L":

To adjust the left rear speaker level.

"REAR R":

To adjust the right rear speaker level.

- 2) Press **CONTROL UP ▲/DOWN ▼** to adjust the selected speaker output level (from -10 dB to +10 dB).

- 3) Repeat 1) and 2) to adjust the other speaker output levels.

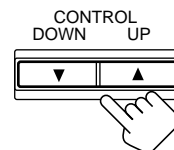

3. Adjust the center tone — for 5 CH Stereo mode only.

- 1) Press **EFFECT** repeatedly until **"CTR TONE"** appears on the display.

The display shows the current setting.

- 2) Press **CONTROL UP ▲/DOWN ▼** to select the center tone level you want.

The center tone adjustment affects the mid-frequency range, which the human voice is mostly made up of.

- Each time you press the button, the display changes to show the following:

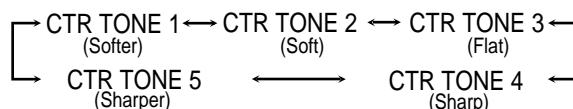

To make the dialogue softer, select "CTR TONE 1" or "CTR TONE 2."

To make the dialogue clearer, select "CTR TONE 4" or "CTR TONE 5."

When "CTR TONE 3" is selected, no adjustment is applied.

From the remote control:

1. Press **DSP MODE** repeatedly until **"5CH STEREO"** or **"4CH STEREO"** appears on the display.

The DSP MODE lamp on the front panel button lights up, and the DSP indicator also lights up on the display.

- "4CH STEREO" appears on the display when you have set "CTR SPK" to "NONE" (see page 17).

2. Press **SOUND**.

The 10 keys are activated for sound adjustments.

3. Select the speaker you want to adjust.

- To select the center speaker level, press **CENTER**— for 5 CH Stereo mode only.

"CTR" appears on the remote control display window.

- To select the left rear speaker level, press **REAR L**.

"REAR L" appears on the remote control display window.

- To select the right rear speaker level, press **REAR R**.

"REARR" appears on the remote control display window.



Continued to the next page.

4. Press **LEVEL +/-** to adjust the speaker output levels (-10 dB to +10 dB).



5. Press **SOUND**.

- To adjust other speaker output levels, repeat steps 3 and 4.

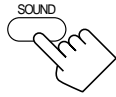

6. Press **CTR TONE** to select the center tone level you want — for 5 CH Stereo mode only.

- Each time you press the button, the display changes to show the following:

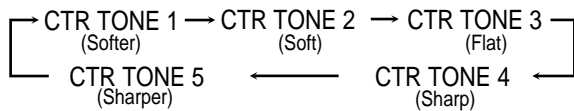

To make the dialogue softer, select “CTR TONE 1” or “CTR TONE 2.”

To make the dialogue clearer, select “CTR TONE 4” or “CTR TONE 5.”

When “CTR TONE 3” is selected, no adjustment is applied.

3. Adjust the center tone.

- Press **EFFECT** repeatedly until “CTR TONE” appears on the display. The display shows the current setting.
- Press **CONTROL UP ▲/DOWN ▼** to select the center tone level you want.

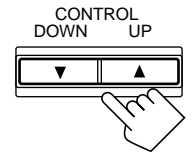
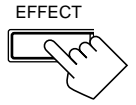

The center tone adjustment affects the mid-frequency range, which the human voice is mostly made up of.

- Each time you press the button, the display changes to show the following:

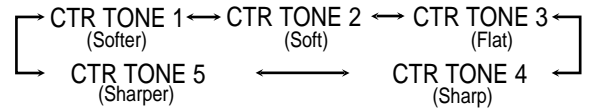

To make the dialogue softer, select “CTR TONE 1” or “CTR TONE 2.”

To make the dialogue clearer, select “CTR TONE 4” or “CTR TONE 5.”

When “CTR TONE 3” is selected, no adjustment is applied.

4. Adjust the overall levels of the effect.

- Press **EFFECT** repeatedly until “EFFECT” appears on the display. The display shows the current setting.
- Press **CONTROL UP ▲/DOWN ▼** to select the effect level you want.

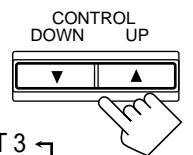
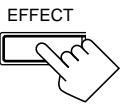

- Each time you press the button, the display changes to show the following:

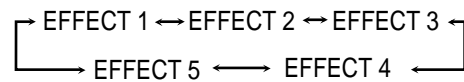

As the number increases, the selected 3D effect mode becomes stronger. (Normally set it to “EFFECT 3.”)

Adjusting the 3D-PHONIC Modes

Before you start, remember...

- Make sure that you have set the speaker information correctly (see page 17).
- There is a time limit in doing the following steps. If the setting is canceled before you finish, start from step 2 again.
- You cannot adjust the center speaker output level when you have set “CTR SPK” to “NONE.” See page 17.
- To adjust the front speaker output balance and subwoofer output level, see pages 16 and 17.

On the front panel:

1. Press **DSP MODE** repeatedly until “3D ACTION” or “3D DIGITAL” appears on the display.

The DSP MODE lamp on the front panel button lights up, and the 3D-PHONIC and DSP indicators also light up on the display.

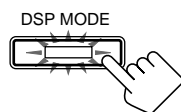

2. Adjust the center speaker output level.

- Press **LEVEL ADJUST** repeatedly until “CENTER” appears on the display.
- Press **CONTROL UP ▲/DOWN ▼** to adjust the center speaker output level (from -10 dB to +10 dB).

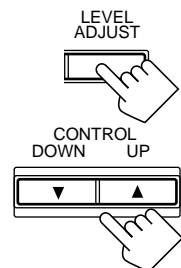

From the remote control:

1. Press **DSP MODE** repeatedly until “3D ACTION” or “3D DIGITAL” appears on the display.

The DSP MODE lamp on the front panel button lights up, and the 3D-PHONIC and DSP indicators also light up on the display.

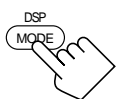

2. Press **SOUND**.

The 10 keys are activated for sound adjustments.

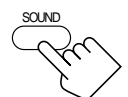

3. Press **CENTER** to select the center speaker.

- “CTR” appears on the remote control display window.



4. Press **LEVEL +/-** to adjust the center speaker output levels (from -10 dB to +10 dB).



5. Press **SOUND**.

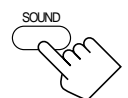

Using the DVD MULTI Playback Mode

This receiver provides the DVD MULTI playback mode for reproducing the analog discrete output mode of the DVD player. Before playing back a DVD, refer also to the manual supplied with the DVD player.

Activating the DVD MULTI Playback Mode

You can adjust the DVD MULTI playback mode while playing back a DVD using the analog discrete output mode on the DVD player. Once you have made adjustments, the receiver memorizes the adjustments until you change them. You also need to set the DVD player to the analog discrete output mode.

Before you start, remember...

- There is a time limit in doing the following steps. If the setting is canceled before you finish, start from step 3 again.
- To adjust the front speaker output balance and subwoofer output level, see pages 16 and 17.

On the front panel:

1. Press DVD MULTI so that “DVD MULTI” appears on the display.

The DVD MULTI lamp on the front panel button lights up.



Note:

When you select “DVD MULTI” as the source to play, the Surround and DSP modes are canceled, and the SURROUND ON/OFF and DSP MODE buttons do not work.

2. Select the analog discrete output mode on the DVD player, and start playing a DVD.

- Refer to the manual supplied with the DVD player.

If you need to make any adjustment, go to the following steps.

3. Adjust the speaker output levels.

- 1) Press LEVEL ADJUST repeatedly until one of the following indications appears on the display.

“CENTER”:

To adjust the center speaker level.

“REAR L”:

To adjust the left rear speaker level.

“REAR R”:

To adjust the right rear speaker level.

- 2) Press CONTROL UP ▲/DOWN ▼ to adjust the selected speaker output level (from -10 dB to +10 dB).

- 3) Repeat 1) and 2) to adjust the other speaker output levels.

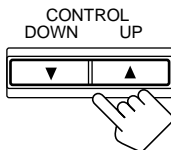

Notes:

- You cannot adjust the center tone level.
- You cannot use the midnight mode for DVD MULTI playback mode (see page 13).
- When using a pair of headphones, the sounds of front left and right are output from the headphones.

From the remote control:

1. Press DVD MULTI so that “DVD MULTI” appears on the display.

The DVD MULTI lamp on the front panel button lights up.

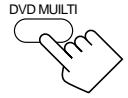

Note:

When you select “DVD MULTI” as the source to play, the Surround and DSP modes are canceled, and the SURROUND ON/OFF and DSP MODE buttons do not work.

2. Select the analog discrete output mode on the DVD player, and start playing a DVD.

- Refer to the manual supplied with the DVD player.

If you need to make any adjustment, go to the following steps.

3. Press SOUND.

The 10 keys are activated for adjusting the sound.

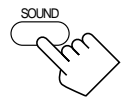

4. Select the speaker you want to adjust.

- To select the center speaker level, press CENTER. “CTR” appears on the remote control display window.
- To select the left rear speaker level, press REAR L. “REAR L” appears on the remote control display window.
- To select the right rear speaker level, press REAR R. “REARR” appears on the remote control display window.



5. Press LEVEL +/- to adjust the speaker output levels (from -10 dB to +10 dB).



6. Press SOUND.

- To adjust other speaker output levels, then repeat steps 4 and 5.

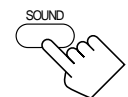

Using the On-Screen Menus

You can use the Menus on the TV screen to control the receiver.

To use this function, you need to connect the TV to the MONITOR OUT jack on the rear panel (see page 7), and set the TV's input mode to the proper position to which the receiver is connected.

- When the TV's input mode is incorrect; for example, if a different video input or TV tuner mode is selected, you cannot show the Menus on the TV screen.

On-Screen Operation buttons (on the remote control)

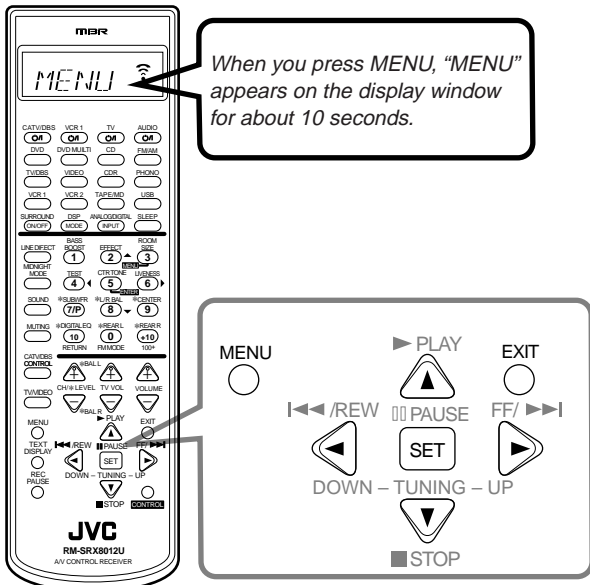

Activating the Surround Modes (Also see page 27)

1. Press MENU.

The MENU appears on the TV.

- Pressing one of the ▲ / ▼ / ◀ / ▶ buttons also displays the MENU.

2. Press ▲ / ▼ to move to "SURROUND."

3. Press ◀ / ▶ to select the Surround mode you want to use.

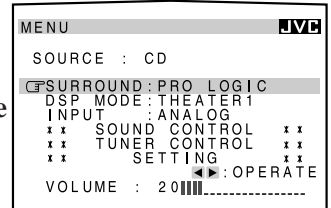

4. When you finish, press EXIT.

The menu disappears from the TV.

Activating the DSP Modes (Also see pages 28 – 34)

1. Press MENU.

The MENU appears on the TV.

- Pressing one of the ▲ / ▼ / ◀ / ▶ buttons also displays the MENU.

2. Press ▲ / ▼ to move to "DSP MODE."

3. Press ◀ / ▶ to select the DSP mode you want to use.

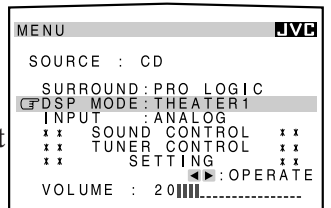

4. When you finish, press EXIT.

The menu disappears from the TV.

Showing the MENU on the TV Screen

Press MENU.

The MENU appears on the TV.

- Pressing one of the ▲ / ▼ / ◀ / ▶ buttons also displays the MENU.

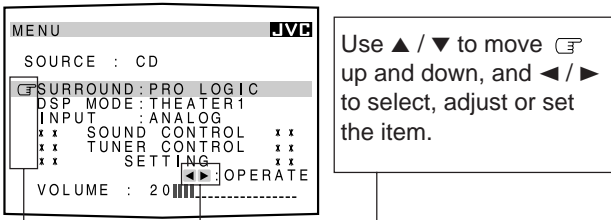

Notes:

- "INPUT" appears only when the digital input (DIGITAL IN) terminal setting has been correctly done for the digital source currently selected. (See page 19.)
- The on-screen display will disappear if no operation is done for about 1 minute.
- The on-screen display is shown in black and white.

Note

If "DVD MULTI" is selected as a playing source, the "SURROUND MODE" and "DSP MODE" do not appear on the display.

Selecting the Analog or Digital Input Mode (Also see page 20)

This selection is only possible when the digital input (DIGITAL IN) terminal setting has been correctly done for the digital source currently selected (see page 19).

1. Press MENU.

The MENU appears on the TV.

- Pressing one of the ▲ / ▼ / ◀ / ▶ buttons also displays the MENU.

2. Press ▲ / ▼ to move to "INPUT."

3. Press ◀ / ▶ to select the analog or digital input mode you want.

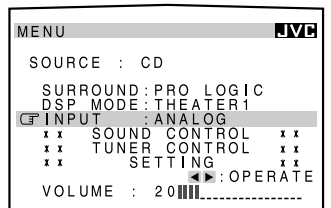

4. When you finish, press EXIT.

The menu disappears from the TV.

Adjusting the Equalization Pattern

(Also see page 15)

1. Press MENU.

The MENU appears on the TV.

- Pressing one of the ▲ / ▼ / ◀ / ▶ buttons also displays the MENU.

2. Press ▲ / ▼ to move to "SOUND CONTROL," then press ◀ / ▶.

The SOUND CONTROL menu appears.

3. Press ▲ / ▼ to move to "DIGITAL EQ," then press ◀ / ▶.

The DIGITAL EQ menu appears.

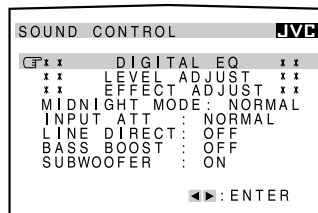

4. Press ▲ / ▼ to move to the frequency you want to adjust.

5. Press ◀ / ▶ to adjust the frequency level you want.

The frequency level changes by 2 dB from -8 dB to +8 dB.

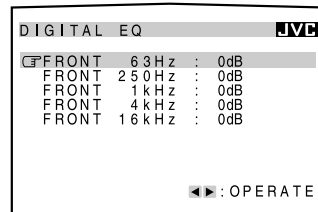

6. When you finish, press EXIT repeatedly until the menu disappears from the TV.

Adjusting the Surround and DSP Modes

(Also see pages 27 – 34)

You can use a Surround mode with a DAP mode, but not with the 5 CH/4 CH Stereo mode and 3D-PHONIC mode.

1. Press MENU.

The MENU appears on the TV.

- Pressing one of the ▲ / ▼ / ◀ / ▶ buttons also displays the MENU.

2. Select Surround mode and/or DSP mode you like to adjust (see page 36).

3. Press ▲ / ▼ to move to "SOUND CONTROL," then press ◀ / ▶.

The SOUND CONTROL menu appears.

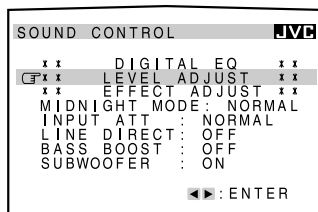

4. Press ▲ / ▼ to move to "LEVEL ADJUST," then press ◀ / ▶.

The LEVEL ADJUST menu appears.

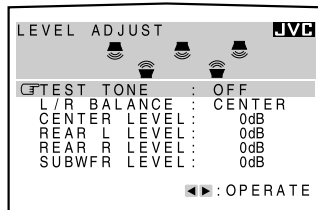

5. Press ▲ / ▼ to move to the item you want to set or adjust, then press ◀ / ▶.

On these adjustment menus, you can do the followings:

For Surround mode, Surround mode with DAP mode:

- "TEST TONE": Output a test tone.
- "L/R BALANCE": Adjust the right and left balance of the front speakers.
- "CENTER LEVEL": Adjust the center speaker output level. *
- "REAR L LEVEL": Adjust the left rear speaker output level. **
- "REAR R LEVEL": Adjust the right rear speaker output level. **
- "SUBWFR LEVEL": Adjust the subwoofer output level. ***

For DAP mode:

- "L/R BALANCE": Adjust the right and left balance of the front speakers.
- "CENTER LEVEL": Adjust the center speaker output level. *
- "REAR L LEVEL": Adjust the left rear speaker output level. **
- "REAR R LEVEL": Adjust the right rear speaker output level. **
- "SUBWFR LEVEL": Adjust the subwoofer output level. ***

For 5 CH/4 CH Stereo mode:

- "L/R BALANCE": Adjust the right and left balance of the front speakers.
- "CENTER LEVEL": Adjust the center speaker output level. ****
- "REAR L LEVEL": Adjust the left rear speaker output level. **
- "REAR R LEVEL": Adjust the right rear speaker output level. **
- "SUBWFR LEVEL": Adjust the subwoofer output level. ***

For 3D-PHONIC mode:

- "L/R BALANCE": Adjust the right and left balance of the front speakers.
- "CENTER LEVEL": Adjust the center speaker output level. *
- "SUBWFR LEVEL": Adjust the subwoofer output level. ***

For Surround off and DSP OFF:

- "L/R BALANCE": Adjust the right and left balance of the front speakers.
- "SUBWFR LEVEL": Adjust the subwoofer output level. ***

Notes:

- * You cannot select "CENTER LEVEL" when "CTR SPK" is set to "NONE" (see page 17).
- ** You cannot select "REAR L LEVEL" and "REAR R LEVEL" when "REAR SPK" is set to "NONE" (see page 17).
- *** You cannot select "SUBWFR LEVEL" when "SUBWOOFER" is set to "NO" (see page 17).
- **** You cannot select "CENTER LEVEL" when 4 CH Stereo mode is selected.

6. Press EXIT once.

7. Press ▲ / ▼ to move  to “EFFECT ADJUST,” then press ◀ / ▶.

The EFFECT ADJUST menu appears.

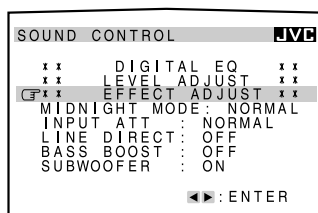

8. Press ▲ / ▼ to move  to the item you want to set or adjust, then press ◀ / ▶.

On these adjustment menus, you can do the followings.

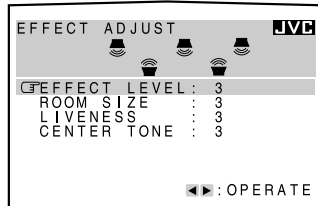

For Surround mode:

“CENTER TONE”: Select the center tone level. *

For DAP mode, Surround mode with DAP:

“EFFECT LEVEL”: Adjust the surround effect level.

“ROOM SIZE”: Adjust the room size effect.

“LIVENESS”: Adjust the liveness level.

“CENTER TONE”: Select the center tone level. *

For 5 CH Stereo mode:

“CENTER TONE”: Select the center tone level.

For 3D-PHONIC mode:

“EFFECT LEVEL”: Adjust the surround effect level.

“CENTER TONE”: Select the center tone level. *

Notes:

- You cannot select “EFFECT ADJUST” in step 7, when both of the Surround and DSP modes are deactivated.
- You cannot select “CENTER TONE” when “CTR SPK” is set to “NONE” (see page 17).

9. When you finish, press EXIT repeatedly until the menu disappears from the TV.

Adjusting the DVD MULTI Playback Mode
(Also see page 35)

1. Select DVD MULTI as the playing source.

Press DVD MULTI.

2. Press MENU.

The MENU appears on the TV.

- Pressing one of the ▲ / ▼ / ◀ / ▶ buttons also displays the MENU.

3. Press ▲ / ▼ to move  to “SOUND CONTROL,” then press ◀ / ▶.

The SOUND CONTROL menu appears.

4. Press ▲ / ▼ to move  to “LEVEL ADJUST,” then press ◀ / ▶.

The LEVEL ADJUST menu appears.

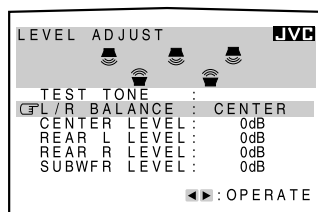

5. Press ▲ / ▼ to move  to the item you want to set or adjust, then press ◀ / ▶.

On this adjustment menu, you can do the following:

“L/R BALANCE”: Adjust the right and left balance of the front speakers.

“CENTER LEVEL”: Adjust the center speaker output level.

“REAR L LEVEL”: Adjust the left rear speaker output level.

“REAR R LEVEL”: Adjust the right rear speaker output level.

“SUBWFR LEVEL”: Adjust the subwoofer output level.

6. When you finish, press EXIT repeatedly until the menu disappears from the TV.

Listening at Night — Midnight Mode
(Also see page 13)

1. Press MENU.

The MENU appears on the TV.

- Pressing one of the ▲ / ▼ / ◀ / ▶ buttons also displays the MENU.

2. Press ▲ / ▼ to move  to “SOUND CONTROL,” then press ◀ / ▶.

The SOUND CONTROL menu appears.

3. Press ▲ / ▼ to move  to “MIDNIGHT MODE.”

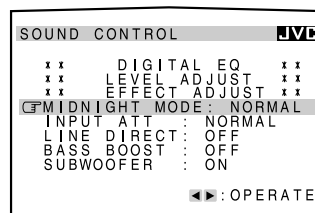

4. Press ◀ / ▶ to select the mode you want to use.

5. When you finish, press EXIT repeatedly until the menu disappears from the TV.

Attenuating the Input Signal
(Also see page 14)

1. Press MENU.

The MENU appears on the TV.

- Pressing one of the ▲ / ▼ / ◀ / ▶ buttons also displays the MENU.

2. Press ▲ / ▼ to move  to “SOUND CONTROL,” then press ◀ / ▶.

The SOUND CONTROL menu appears.

3. Press ▲ / ▼ to move  to “INPUT ATT.”

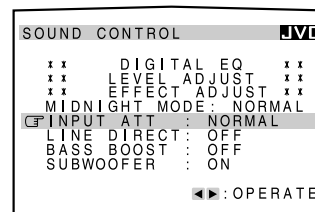

4. Press ◀ / ▶ to select the Input Attenuator mode “ATT ON” or “NORMAL.”

5. When you finish, press EXIT repeatedly until the menu disappears from the TV.

■ Selecting the Line Direct Function

(Also see page 14)

1. Press MENU.

The MENU appears on the TV.

- Pressing one of the ▲ / ▼ / ◀ / ▶ buttons also displays the MENU.

2. Press ▲ / ▼ to move to "SOUND CONTROL," then press ◀ / ▶.

The SOUND CONTROL menu appears.

3. Press ▲ / ▼ to move to "LINE DIRECT."

4. Press ◀ / ▶ to turn the line direct function "ON" or "OFF."

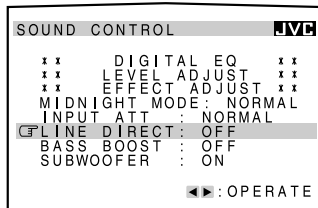

5. When you finish, press EXIT repeatedly until the menu disappears from the TV.

■ Selecting the Bass Boost Function

(Also see page 14)

1. Press MENU.

The MENU appears on the TV.

- Pressing one of the ▲ / ▼ / ◀ / ▶ buttons also displays the MENU.

2. Press ▲ / ▼ to move to "SOUND CONTROL," then press ◀ / ▶.

The SOUND CONTROL menu appears.

3. Press ▲ / ▼ to move to "BASS BOOST."

4. Press ◀ / ▶ to turn the bass boost function "ON" or "OFF."

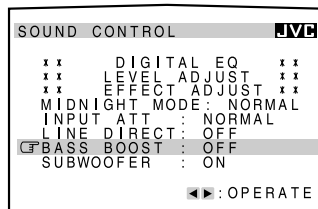

5. When you finish, press EXIT repeatedly until the menu disappears from the TV.

■ Activating the Subwoofer Sound

(Also see page 14)

1. Press MENU.

The MENU appears on the TV.

- Pressing one of the ▲ / ▼ / ◀ / ▶ buttons also displays the MENU.

2. Press ▲ / ▼ to move to "SOUND CONTROL," then press ◀ / ▶.

The SOUND CONTROL menu appears.

3. Press ▲ / ▼ to move to "SUBWOOFER."

4. Press ◀ / ▶ to turn the subwoofer output "ON" or "OFF."

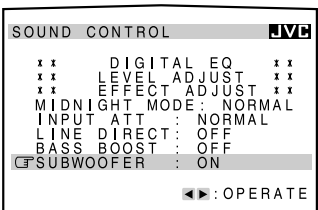

5. When you finish, press EXIT repeatedly until the menu disappears from the TV.

■ Operating the Tuner (Also see pages 22 and 23)

1. Select FM or AM as the playing source.

Press FM/AM.

2. Press MENU.

The MENU appears on the TV.

- Pressing one of the ▲ / ▼ / ◀ / ▶ buttons also displays the MENU.

3. Press ▲ / ▼ to move to "TUNER CONTROL," then press ◀ / ▶.

The TUNER CONTROL menu appears.

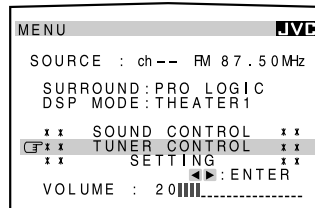

4. Press ▲ / ▼ to move to the item you want to set or adjust, then press ◀ / ▶.

On the TUNER CONTROL menu, you can do the following:

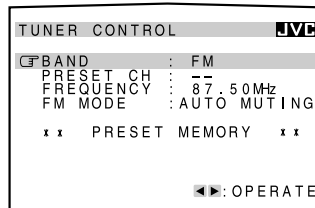

"BAND":	Select the band.
"PRESET CH":	Select a preset channel station.
"FREQUENCY":	Tune in a station manually.
"FM MODE":	Select the FM reception mode.*
"PRESET MEMORY":	See "Storing the Preset Stations."

Note:

* Not displayed when an AM station is selected.

5. When you finish, press EXIT repeatedly until the menu disappears from the TV.

■ Storing the Preset Stations (Also see page 22)

1. Press MENU.

The MENU appears on the TV.

- Pressing one of the ▲ / ▼ / ◀ / ▶ buttons also displays the MENU.

2. Press ▲ / ▼ to move to "TUNER CONTROL," then press ◀ / ▶.

The TUNER CONTROL menu appears.

3. Tune into a station on the TUNER CONTROL menu, referring to "Operating the Tuner".

4. Press ▲ / ▼ to move to "PRESET MEMORY," then press ◀ / ▶.

 moves to "PRESET CH" and the channel number starts flashing.

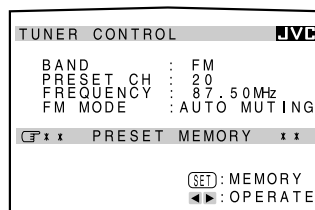

5. Press ◀ / ▶ to select a preset station number you want.

6. Press SET to store the setting.

The selected channel number stops flashing.

7. When you finish, press EXIT repeatedly until the menu disappears from the TV.

Setting the Basic Setting Items

(Also see pages 16 – 21)

1. Press MENU.

The MENU appears on the TV.

- Pressing one of the ▲ / ▼ / ◀ / ▶ buttons also displays the MENU.

2. Press ▲ / ▼ to move

☞ to “SETTING,” then press ◀ / ▶.

The SETTING 1 appears.

3. Press ▲ / ▼ to move

☞ to the item you want to set or adjust, then press ◀ / ▶.

- To go to the SETTING 2 menu, move ☞ to “NEXT PAGE,” then press ◀ / ▶.
- To go back to the SETTING 1 menu, move ☞ to “PREVIOUS PAGE,” then press ◀ / ▶.

On the SETTING 1 and 2 menus, you can do the following:

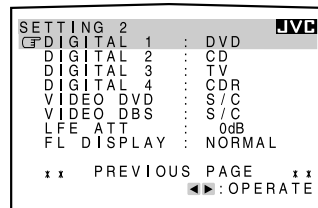
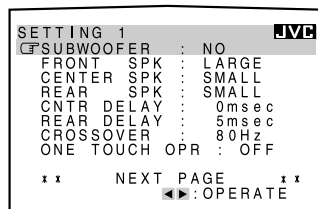
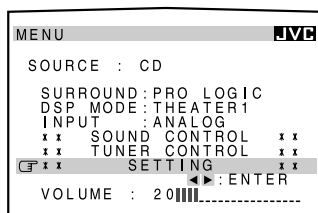

SETTING 1 menu

- “SUBWOOFER”: Set the subwoofer information (see page 17).
- “FRONT SPK”: Set the front speaker information (see page 17).
- “CENTER SPK”: Set the center speaker information (see page 17).
- “REAR SPK”: Set the rear speaker information (see page 17).
- “CNTR DELAY”: Adjust the delay time of the center speaker output (see page 18). *
- “REAR DELAY”: Adjust the delay time of the rear speaker output (see page 18). **
- “CROSSOVER”: Set the crossover frequency (see page 18).
- “ONE TOUCH OPR”: Set the one touch operation (see page 21).

SETTING 2 menu

- “DIGITAL 1/2/3/4”: Set the digital input terminal 1/2/3/4 (see page 19).
- “VIDEO DVD”: Set the video input terminal for the DVD player (see page 16).
- “VIDEO DBS”: Set the video input terminal for the DBS tuner (see page 16).
- “LFE ATT”: Set the low frequency effect attenuator level (see page 19).
- “FL DISPLAY”: Shows the disc text information on the display (see page 21).

Notes:

- * You cannot select “CNTR DELAY” when “CTR SPK” is set to “NONE” (see page 17).
- ** You cannot select “REAR DELAY” when “REAR SPK” is set to “NONE” (see page 17).

4. When you finish, press EXIT repeatedly until the menu disappears from the TV.

COMPU LINK Remote Control System

The COMPU LINK remote control system allows you to operate JVC audio components through the remote sensor on the receiver.

To use this remote control system, you need to connect JVC audio components through the COMPU LINK (SYNCHRO) jacks (see below) in addition to the connections using cables with RCA pin plugs (see pages 5 and 6).

- Make sure that the AC power cords of these components are unplugged before connection. Plug the AC power cords only after all connections are complete.

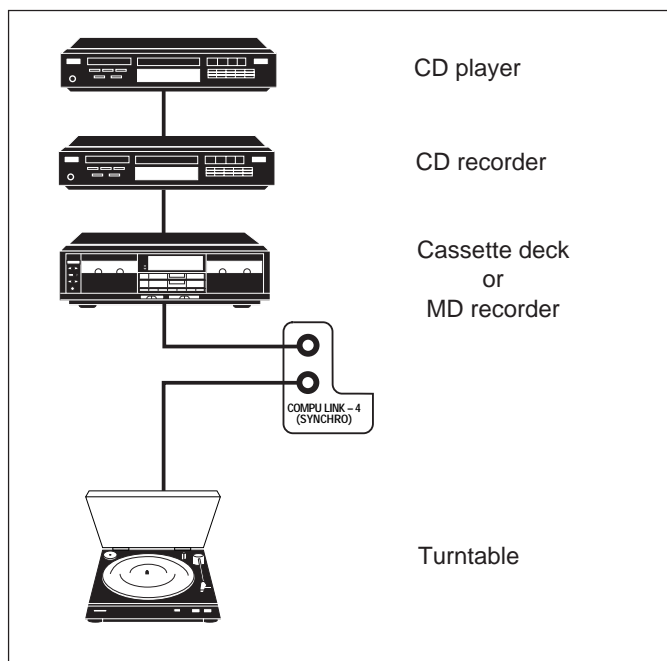

Notes:

- There are four versions of COMPU LINK remote control system. This receiver is equipped with the fourth version — COMPU LINK-4. This version is added systematic operations with the CD recorder to the previous version — COMPU LINK-3.
- If your audio component has two COMPU LINK jacks, you can use either one. If it has only one COMPU LINK jack, connect it so that it is the last item in the series of components. (For example, the turntable or CD player in the diagram above.)
- To operate the cassette deck or MD recorder using the COMPU LINK remote control system, set the source name correctly. (See page 16.)
- Refer also to the manuals supplied with your audio components.

This remote control system allows you to use four functions listed below.

Remote Control through the Remote Sensor on the Receiver

You can control the connected audio components through the remote sensor on the receiver using this remote control. Aim the remote control directly at the remote sensor on the receiver. For details, see pages 49 and 50.

Automatic Source Selection

When you press the play (▶) button on a connected component or on its own remote control, the receiver automatically turns on and changes the source to the component. On the other hand, if you select a new source on the receiver or on the remote control, the selected component begins playing immediately.

In both cases, the previously selected source continues playing without sound for a few seconds.

Automatic Power On/Off (Standby): only possible with the COMPU LINK-3 and COMPU LINK-4 connection

The connected components turn on and off (standby) along with the receiver.

When you turn on the receiver, one of the connected components will turn on automatically, depending on which component has been previously selected.

When you turn off the receiver, the connected components will turn off (standby).

Synchronized Recording

Synchronized recording means the cassette deck (or MD recorder) starts recording as soon as a CD begins playing.

To use synchronized recording, follow these steps:

1. Put a tape in the cassette deck (or an MD in the MD recorder), and a disc in the CD player.
2. Press the record (●) button and the pause (II) button on the cassette deck (or MD recorder) at the same time.

This puts the cassette deck (or MD recorder) into recording pause.

If you do not press the record (●) button and pause (II) button at the same time, the synchronized recording feature will not operate.

3. Press the play (▶) button on the CD player.

The source changes on the receiver, and as soon as play starts, the cassette deck (or MD recorder) starts recording. When the play ends, the cassette deck (or MD recorder) enters recording pause, and stops about 4 seconds later.

Notes:

- During synchronized recording, the selected source cannot be changed.
- If the power of any component is shut off during synchronized recording, the COMPU LINK remote control system may not operate properly. In this case, you must start again from the beginning.

TEXT COMPU LINK Remote Control System

The TEXT COMPU LINK remote control system has been developed to deal with the disc information recorded in the CD Text* and MDs. Using these information in the discs, you can operate the CD player or MD recorder equipped with the TEXT COMPU LINK remote control system through the receiver.

CONNECTIONS:

To use this remote control system, you need to connect the CD player and/or MD recorder you want to operate, following the procedures below.

1. If you have already plugged your CD player, MD recorder, and this receiver into the AC outlets, unplug their AC power cords first.
2. Connect your CD player, MD recorder, and this receiver as follows, through the COMPU LINK jacks and TEXT COMPU LINK jacks.

- 1) **COMPU LINK jacks:** Use the cables with the monaural mini-plugs (not supplied with this receiver).

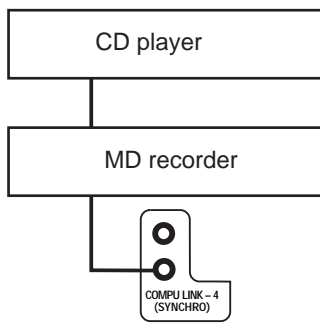

- 2) **TEXT COMPU LINK jacks:** Use the cables with the stereo mini-plugs (not supplied with this receiver).

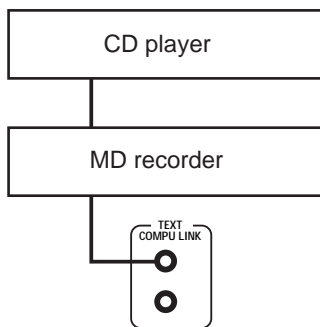

3. Connect your CD player, MD recorder and this receiver, using the cables with RCA pin plugs (see pages 5 and 6).
4. Plug the AC power cords of these components above into the AC outlets.
5. When turning on these components for the first time, turn on the connected components first, then turn on this receiver.

FUNCTIONS:

This remote control system allows you to use the functions listed below.

Displaying the Disc Information on the TV screen

Disc information such as its performer and disc title (and track titles only when a CD Text is selected) is shown on the TV screen.

Disc Search: Only for CD Player

This remote control system can allow you to search for discs by the performer, disc title, and music genre.

With this disc search, you can easily find the disc you want to play.

Disc Title Input:

If your CD player or MD recorder has the disc memory function, you can input the following information about the normal audio CDs or MDs on the TV screen.

- For CDs: Performer, disc title, and music genre
- For MDs: Disc title and song titles

*What is a CD Text?

In a CD Text, some information about the disc (its disc title, performer, composer, arranger, etc.) is recorded.

Notes:

- If your audio component has two COMPU LINK jacks, you can use either one. If it has only one COMPU LINK jack, connect it so that it is the last item in the series of components. (For example, the CD player in the diagram in the left column.)
- If your audio component has two TEXT COMPU LINK jacks, you can use either one. If it has only one TEXT COMPU LINK jack, connect it so that it is the last item in the series of components. (For example, the CD player in the diagram in the left column.)
- "TEXT COMPULINK SOURCE NOT CONNECTED" appears on the display in the following cases:
 - When the connections explained in the left column are not correctly done.
 - When you try to use the TEXT COMPU LINK function a few seconds after you turn on the connected equipment. This is not a malfunction of the units.
- Refer also to the manuals supplied with your CD player or MD recorder.

IMPORTANT:

If you turn on the receiver before turning on the other components after connecting the components, the TEXT COMPU LINK remote control system does not work correctly.

If this happens:

1. Turn off all the components including this receiver.
2. Turn on the connected components.
3. Turn on this receiver.

OPERATIONS:

To use this remote control system, you need to connect the TV to the MONITOR OUT jack on the rear panel (see page 7), and set the TV's input mode to the proper position to which the receiver is connected. **Make sure you have connected the CD player or MD recorder equipped with the TEXT COMPU LINK remote control system. If not, you cannot use the following functions.**

On-Screen Operation buttons (on the remote control)

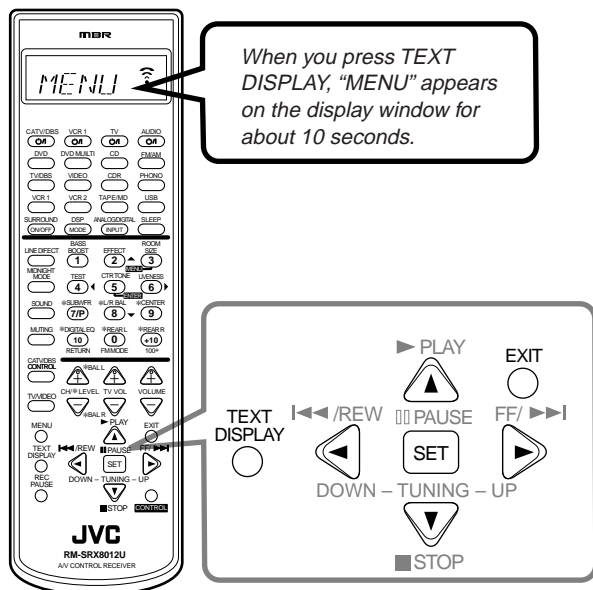

- ① Source name: CD or MD
- ② Select ▲ or ▼, then press SET to change the disc.
- ③ Track numbers and track titles.
 - When you move ⏪ to a track number, you can change the track information by pressing ◀/▶. Each time you press the button, track information alternates between its track title and its performer. (You can also start playing the track by pressing SET.)
- ④ Select this (move ⏪ in front), then press SET to go to the DISC SEARCH screen (see page 44).
- ⑤ Select this (move ⏪ in front), then press SET to go to the TITLE INPUT screen (see page 45).
- ⑥ This appears only when a CD Text is selected.
- ⑦ Disc information such as the disc title, performer, and music genre.

When this is selected (⏪ in front), you can change the disc information by pressing ◀/▶. Each time you press the button, disc information (see “Note on ⑦”) changes.
- ⑧ Select ▲ or ▼, then press SET to change the track.
- ⑨ Usable buttons and their functions for the current selection.

Indication here will be changed according to what is currently selected (⏪ in front) on the screen. See “Note on ⑨.”

Note on ⑦:

The following information will appear on the display:

- For CD Texts — Disc title, Performer, Genre, Song writer, Composer, Arranger, Message
Only recorded information will be shown. If there is no data, “NO DATA” will appear.
- For MDs — Disc title
If there is no data, “NO DATA” will appear.

Note on ⑨:

For example, the SET button will be used to start play (PLAY), to go to the next screen (ENTER), and to determine the selection (ENTER).

To exit from the Disc information screen:

Press EXIT.

Notes:

- The on-screen display will disappear in the following cases:
 - if no operation is done for about 10 minutes.
 - if you do any operation other than explained in this section.
- To control the MD recorder using the TEXT COMPU LINK remote control system, you have to change the source name shown on the display from “TAPE” to “MD.” (See page 16.)
- Some special characters and marks cannot be displayed correctly.
- The on-screen display is shown in black and white.

Showing the Disc Information on the TV Screen

Press TEXT DISPLAY while “CD” or “MD” is selected as the source.

The Disc Information screen appears on the TV.

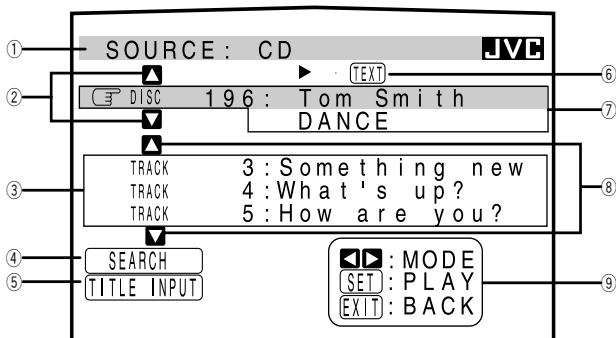

■ Searching for a Disc (Only for the CD player)

Search for a disc by its performer:

1. Press **TEXT DISPLAY** while “CD” is selected as the source.

The Disc Information screen appears on the TV.

2. Press **▲ / ▼** to move **⇨** to “SEARCH,” then press **SET**.

The DISC SEARCH screen appears.

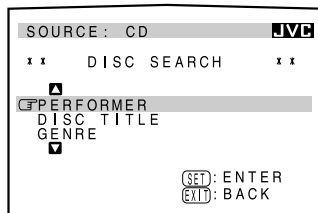

3. Press **▲ / ▼** to move **⇨** to “PERFORMER,” then press **SET**.

The PERFORMER SEARCH screen appears.

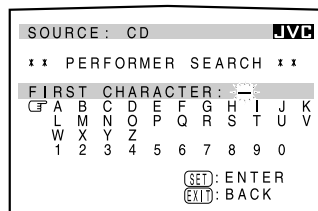

4. Press **▲ / ▼ / ◀ / ▶** to move **⇨** in front of the first character of the performer you want to search for, then press **SET**.

To correct the incorrect entry, press **▲ / ▼ / ◀ / ▶** to move **⇨** in front of the correct character, then press **SET**.

Note:

Symbols such as @, # or \$ cannot be available for search.

5. Press **SET** again.

Disc search starts, then the SEARCH RESULT screen, showing the performers, appears.

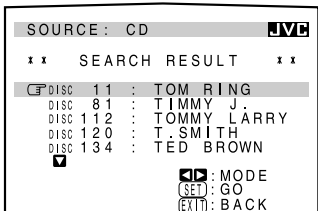

6. On the SEARCH RESULT screen, you can do the following:

- **Changing the indication of the disc information:** Press **▲ / ▼** to move **⇨** to a searched disc, then press **◀ / ▶**. Each time you press **◀ / ▶**, the disc information alternates between its performer and its disc title.
- **Starting a disc play and going to the Disc Information screen (see page 43):** Press **▲ / ▼** to move **⇨** to a searched disc, then press **SET**.
- **Showing unseen disc information (if more than 5 discs are listed as a result of the search):** Press **▲ / ▼** until they appear.
- **Going back to the PERFORMER SEARCH screen:** Press **EXIT**.

Search for a disc by its disc title:

1. Press **TEXT DISPLAY** while “CD” is selected as the source.

The Disc Information screen appears on the TV.

2. Press **▲ / ▼** to move **⇨** to “SEARCH,” then press **SET**.

The DISC SEARCH screen appears.

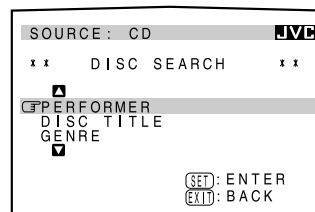

3. Press **▲ / ▼** to move **⇨** to “DISC TITLE,” then press **SET**.

The DISC TITLE SEARCH screen appears.

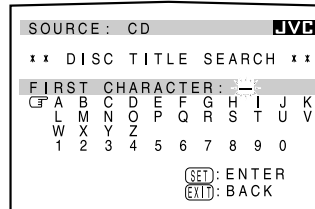

4. Press **▲ / ▼ / ◀ / ▶** to move **⇨** in front of the first character of the disc title you want to search for, then press **SET**.

To correct the incorrect entry, press **▲ / ▼ / ◀ / ▶** to move **⇨** in front of the correct character, then press **SET**.

Note:

Symbols such as @, # or \$ cannot be available for search.

5. Press **SET** again.

Disc search starts, then the SEARCH RESULT screen, showing the disc titles, appears.

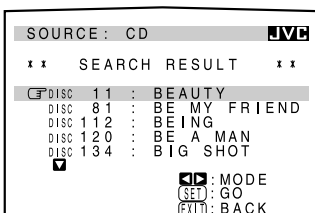

6. On the SEARCH RESULT screen, you can do the following:

- **Changing the indication of the disc information:** Press **▲ / ▼** to move **⇨** to a searched disc, then press **◀ / ▶**. Each time you press **◀ / ▶**, the disc information alternates between its disc title and its performer.
- **Starting a disc play and going to the Disc Information screen (see page 43):** Press **▲ / ▼** to move **⇨** to a searched disc, then press **SET**.
- **Showing unseen disc information (if more than 5 discs are listed as a result of the search):** Press **▲ / ▼** until they appear.
- **Going back to the DISC TITLE SEARCH screen:** Press **EXIT**.

Search for a disc by its genre:

1. Press **TEXT DISPLAY** while “CD” is selected as the source.

The Disc Information screen appears on the TV.

2. Press **▲ / ▼** to move **⇨** to “SEARCH,” then press **SET**.

The DISC SEARCH screen appears.

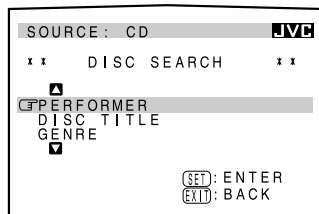

3. Press **▲ / ▼** to move **⇨** to “GENRE,” then press **SET**.

The GENRE SEARCH screen appears.

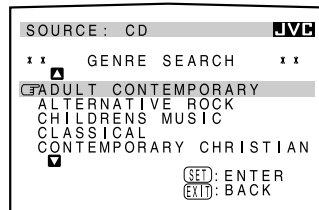

4. Press **▲ / ▼** to move **⇨** to the genre you want to search for, then press **SET**.

To show the unseen genres, press **▲ / ▼** until they appear.

Disc search starts, then the SEARCH RESULT screen, showing the disc titles, appears.

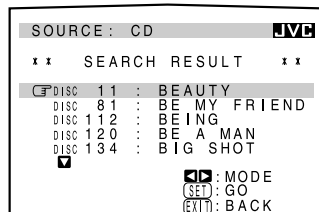

5. On the SEARCH RESULT screen, you can do the following:

- **Changing the indication of the disc information:** Press **▲ / ▼** to move **⇨** to a searched disc, then press **◀ / ▶**. Each time you press **◀ / ▶**, the disc information alternates between its disc title and its performer.
- **Starting a disc play and going to the Disc Information screen (see page 43):** Press **▲ / ▼** to move **⇨** to a searched disc, then press **SET**.
- **Showing unseen disc information (if more than 5 discs are listed as a result of the search):** Press **▲ / ▼** until they appear.
- **Going back to the GENRE SEARCH screen:** Press **EXIT**.

Entering the Disc Information**For the CD Player with the disc memory function:**

You can use the disc memory function through this receiver.

The disc information (its performer, disc title, and music genre) of normal audio CDs will be stored into the memory built in the CD player.

For the disc memory function, refer to the manual supplied with your CD player.

- The performer, disc title, and music genre information are usually recorded in a CD Text. However, if a CD Text has no genre information recorded in the disc itself, you can input its music genre by yourself.

Note:

You can enter the TITLE INPUT screens for a CD Text and input its titles. However, you cannot store the titles you have input for a CD Text.

Example: Entering the following information for Disc 1
Performer: “MICHAEL”
Disc title: “MY FAVORITE”

1. Press **TEXT DISPLAY** while “CD” is selected as the source.

The Disc Information screen appears on the TV.

2. Press **▲ / ▼** to move **⇨** to “TITLE INPUT,” then press **SET**.

The TITLE INPUT/PERFORMER screen appears.

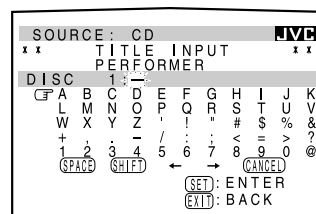

3. Press **▲ / ▼ / ◀ / ▶** to move **⇨** in front of a character you want, then press **SET** to enter the character.

- If the current CD is a CD Text, go to step 5 without entering the performer.

To use the lower case letters, press **▲ / ▼ / ◀ / ▶** to move **⇨** to **(SHIFT)**, then press **SET**.

To use the upper case letters again, press **▲ / ▼ / ◀ / ▶** to move **⇨** to **(SHIFT)**, then press **SET**.

4. Repeat step 3 until you finish putting a performer name (up to 32 characters).

To insert a space, press ▲/▼ / ◀/▶ to move **CF** to **SPACE**, then press SET.

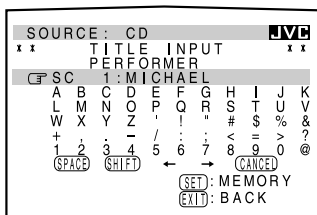

To correct an incorrect character:

- 1) Press ▲/▼/◀/▶ to move **CF** to ← or →, then press SET until the incorrect character is selected.
- 2) Press ▲/▼/◀/▶ to move **CF** to **CANCEL**, then press SET to erase the character.
- 3) Press ▲/▼/◀/▶ to move **CF** in front of the correct character, then press SET to enter the correct character.

5. Press ▲/▼/◀/▶ to move **CF** to “DISC 1: MICHAEL (in this example),” then press SET.

The TITLE INPUT: DISC TITLE screen appears.

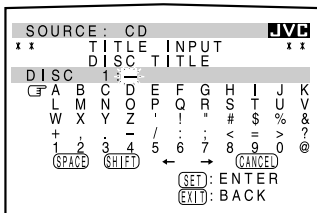

6. Enter the disc title, referring to steps 3 and 4.

- If the current CD is a CD Text, go to the next step without entering the disc title.

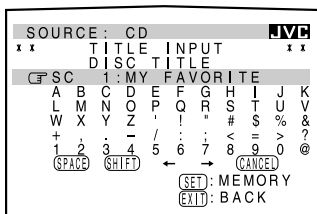

7. Press ▲/▼/◀/▶ to move **CF** to “DISC 1: MY FAVORITE (in this example),” then press SET.

The TITLE INPUT: DISC 1 GENRE screen appears.

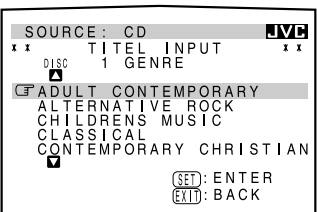

8. Press ▲/▼ to move **CF** to the genre you want, then press SET.

The Disc Information screen appears again.

To show the unseen genres, press ▲/▼ until they appear.

For the MD recorder:

You can write the disc information (disc title and song titles) into the disc. You can only write the song title for the song currently selected.

- If you have the CD-MD combination deck, you can also enter the disc information (its performer, disc title, and its music genre) of normal audio CDs into the memory built in the CD-MD combination deck. (To do this, follow the procedure of “For the CD Player with the disc memory function.”)
- If you change the disc or song title with more than 32 characters, the characters following 32nd will be erased from the title.

1. Press **TEXT DISPLAY** while “MD” is selected as the source.

The Disc Information screen appears on the TV.

2. Press ▲/▼ to move **CF** to “TITLE INPUT,” then press SET.

The DISC TITLE INPUT screen appears.

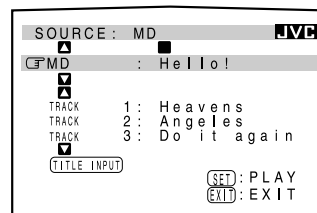

3. Enter the title, referring to steps 3 and 4 of “For the CD Player with the disc memory function.”

- You can enter up to 32 characters for the disc title.

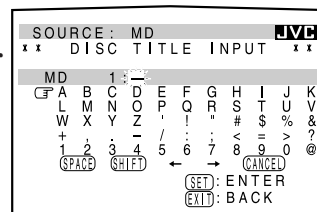

4. Press ▲/▼/◀/▶ to move **CF** to the disc title you have just entered, then press SET.

The disc title is stored into the memory, and the SONG TITLE INPUT screen for the currently selected song appears.

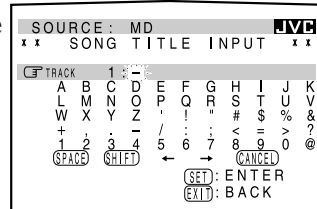

- You can enter a song title for the song currently selected.

5. Enter the song title, referring to steps 3 and 4 of “For the CD Player with the disc memory function.”

- You can enter up to 32 characters for the song title.

6. Press ▲/▼/◀/▶ to move **CF** to the song title you have just entered, then press SET.

The song title is stored into the memory, and the Disc Information screen appears again.

AV COMPU LINK Remote Control System

The AV COMPU LINK remote control system allows you to operate JVC video components (TV, VCR, and DVD player) through the receiver.

This receiver is equipped with the AV COMPU LINK-III, which added a function to operate JVC video components through the video components terminals. To use this remote control system, you need to connect the video components you want to operate, following the diagrams below and the procedure on the next page.

CONNECTIONS 1: AV COMPU LINK Connection

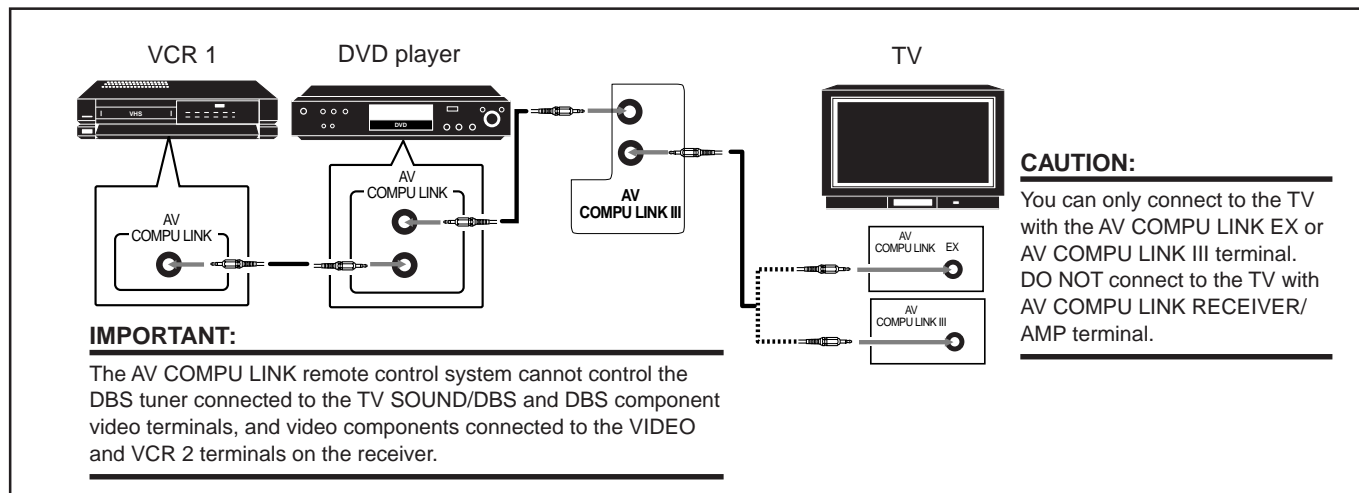



Notes:

- When connecting the receiver and a TV with the AV COMPU LINK EX terminal by using a component video cable, you cannot use Automatic Selection of TV's Input Mode (see page 48).
- When connecting only the VCR 1 or DVD player to this receiver, connect it directly to the receiver using cables with the monaural mini-plugs.
- Refer also to the manuals supplied with your video components.

CONNECTIONS 2: Video Cable Connection

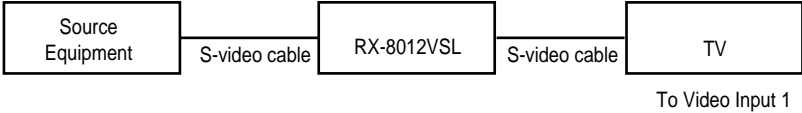
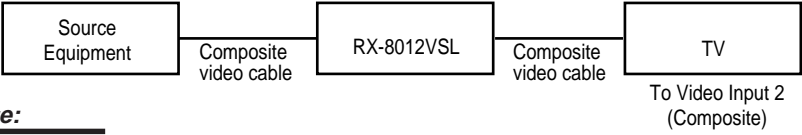
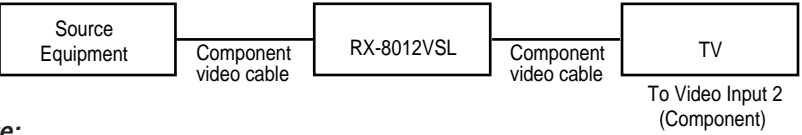
This receiver is equipped with three types of the video terminals — S-video, composite video, or component video, and the signals coming into this receiver through one type of video terminals can output only through the same type of the terminal. So you need to connect the VCR and/or DVD player to the TV using one of the following three ways:

<p>CASE 1</p>	<p>When connecting the source equipment to the receiver using the S-video terminals, connect also this receiver to the TV's Video Input 1 terminal using S-video cables.</p>  <p>Note: If you connect the DVD player and the DBS tuner to this receiver using the S-video terminals, change the video input terminal setting to "S/C" (see page 16).</p>
<p>CASE 2</p>	<p>When connecting the source equipment to the receiver using the composite video terminals, connect also this receiver to the TV's Video Input 2 terminal (composite video input) using composite video cables.</p>  <p>Note: If you connect the DVD player and the DBS tuner to this receiver using the composite video terminals, change the video input terminal setting to "S/C" (see page 16).</p>
<p>CASE 3</p>	<p>When connecting the source equipment to the receiver using the component video terminals, connect also this receiver to the TV's Video Input 2 terminals (component video input) using component video cables.</p>  <p>Note: If you connect the DVD player and the DBS tuner to this receiver using the video component terminals, change the video input terminal setting to "COMPNT" (see page 16).</p>

1. **If you have already plugged your VCR 1 (VCR connected to the VCR 1 jacks), DVD player, TV and this receiver into the AC outlets, unplug their AC power cords first.**
2. **Connect your VCR 1, DVD player, TV and this receiver as follows, using the cables with the monaural mini-plugs (not supplied).**
 - See “CONNECTIONS 1” on the previous page.
3. **Connect the audio input/output jacks on VCR 1, DVD player, TV and this receiver using the cables with RCA pin plug.**
 - See pages 6 and 7.
4. **Connect the video input/output jacks on VCR 1, DVD player, TV and this receiver, using the cables with RCA pin plug, with S-video plug or with component video plugs.**
 - See “CONNECTIONS 2” on the previous page.
5. **Plug the AC power cords of the components into the AC outlets.**
6. **When turning on the TV for the first time after the AV COMPU LINK connection, turn the TV volume to the minimum using the TV volume control on the TV.**
7. **Turn on the other connected components first, then turn on this receiver.**
 - When turning on the VCR 1, use the remote control supplied with this receiver (press VCR 1 ).

The AV COMPU LINK remote control system allows you to use the five basic functions listed below.

Remote Control of the TV, DVD player, and VCR Using This Remote Control

See page 51 for details.

- Aim the remote control directly at **the remote sensor on each target component.**

One-Touch Video Play

Simply by inserting a video cassette without its safety tab into the VCR 1 (the VCR connected to the VCR 1 jacks), you can enjoy the video playback without setting other switches manually. The receiver automatically turns on and changes the source to “VCR 1.” The TV automatically turns on and changes the input mode to the position so that you can view the playback picture. When you insert a video cassette with its safety tab, press the play () button on the VCR 1 or on the remote control. So, you can get the same result.

One-Touch DVD Play

Simply by starting playback on the DVD player, you can enjoy the DVD playback without setting other switches manually.

- When the DVD player is connected through the analog input jacks on this receiver (and analog input is selected), the receiver automatically turns on and changes the source to “DVD” or “DVD MULTI.”
- When the DVD player is connected through the digital input terminal on this receiver (and digital input is selected), the receiver automatically turns on and changes the source to “DVD DGTL.”

The TV automatically turns on and changes the input mode to the appropriate position so that you can view the playback picture.

Automatic Selection of TV's Input Mode

- When you select “TV” as the source to play on the receiver, the TV automatically changes the input mode to the TV tuner so that you can watch TV.
- When you select “DVD,” “DVD MULTI,” “VCR 1,” “VCR 2,” “VIDEO” or “DBS” as the source to play on the receiver, the TV automatically changes the input mode to the appropriate position (either Video Input 1 or Video Input 2) so that you can view the playback picture.

Notes:

- When connecting a TV with the AV COMPU LINK EX terminal to this receiver, you cannot use a component video cable (as case 3 on page 47). Connect the TV using a S-video or composite video cable (as cases 1 and 2).
- When you select “TV” as the source on the receiver, you cannot see the menu on the TV screen since the AV COMPU LINK remote control system automatically changes the TV's input mode to the TV tuner.
If you do not mind stopping listening to the TV sounds, you can then show the on-screen displays after changing the TV's input mode to the appropriate position the receiver is connected to.

Automatic Power On/Off

The TV, VCR 1 (the VCR connected to the VCR 1 jacks), and DVD player turn on and off along with the receiver.

When you turn on the receiver;

- If the previously selected source is “VCR 1,” the TV and VCR 1 will turn on automatically.
- If the previously selected source is “VIDEO,” “VCR 2,” “TV” or “DBS,” only the TV will turn on automatically.
- If the previously selected source is “DVD” or “DVD MULTI,” the TV and DVD player will turn on automatically.

When you turn off the receiver, the TV, VCR 1 and the DVD player will turn off.

Note:

If you turn off the receiver while recording on the VCR 1, the VCR 1 will not turn off, but continue recording.

Operating JVC's Audio/Video Components

You can operate JVC's audio and video components with this receiver's remote control, since control signals for JVC components are preset in the remote control.

Operating Audio Components

IMPORTANT:

To operate JVC's audio components using this remote control:

- You need to connect JVC audio components through the COMPU LINK (SYNCHRO) jacks (see page 41) in addition to the connections using cables with RCA pin plugs (see pages 5 and 6).
- Aim the remote control directly at the remote sensor on the receiver.
- If you use the buttons on the front panel or the menu function to choose a source, the remote control will not operate that source. To operate a source with the remote control, the source must be selected using source selecting buttons on the remote control.
- To operate the cassette deck or MD recorder using the COMPU LINK remote control system, set the source name correctly. (See page 16.)
- Refer also to the manuals supplied with your components.

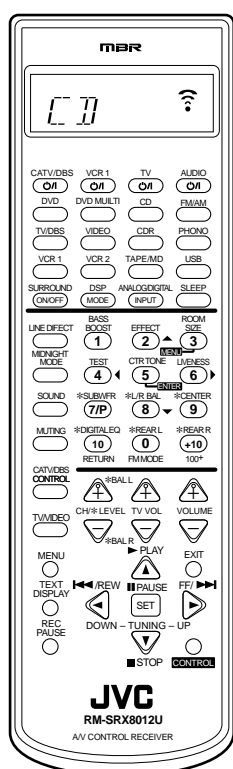

Note:

When you press one of the following buttons mentioned in this section, the operation mode appears on the display window for about 10 seconds. For example, the above illustration shows that you have pressed CD.

Buttons	Indications						
FM/AM	TUNER						
CD	CD						
CDR	CDR						
PHONO	PHONO						
TAPE/MD	TAPE						
CONTROL (repeatedly)	<table border="0"> <tr> <td>VCR 1</td> <td>→</td> <td>TAPE</td> </tr> <tr> <td>CDDSC</td> <td>←</td> <td>CDR</td> </tr> </table>	VCR 1	→	TAPE	CDDSC	←	CDR
VCR 1	→	TAPE					
CDDSC	←	CDR					
SOUND	SOUND						

Tuner

You can always perform the following operations:

FM/AM: Alternates between FM and AM.

After pressing FM/AM, you can perform the following operations:

1 – 10, +10: Selects a preset channel number directly.
 For channel number 5, press 5.
 For channel number 15, press +10, then 5.
 For channel number 20, press +10, then 10.

TUNING UP ►/DOWN ◀: Tunes into stations.
 FM MODE: Changes the FM reception mode.

Sound control section (Amplifier)

You can always perform the following operations:

SURROUND ON/OFF: Turns on or off the Surround modes — Dolby Pro Logic, Dolby Digital, and DTS Digital Surround.

DSP MODE: Selects the DSP modes.

After pressing SOUND, you can perform the following operations:

SUBWFR then LEVEL +/-: Adjusts the subwoofer output level.
 L/R BAL then BAL L/BAL R: Adjusts the front speaker output balance.
 CENTER then LEVEL +/-: Adjusts the center speaker output level.
 REAR L then LEVEL +/-: Adjusts the left rear speaker output level.
 REAR R then LEVEL +/-: Adjusts the right rear speaker output level.
 DIGITAL EQ then LEVEL +/-: Selects the audio band and adjusts its frequency level.

EFFECT: Selects the effect level.

TEST: Turns on or off the test tone output.

CTR TONE: Selects the center tone.

ROOM SIZE: Selects the room size.

LIVENESS: Selects the liveness.

Note:

After adjusting sounds, press the corresponding source selecting button to operate your target source by using the 10 keys; otherwise, the 10 keys cannot be used for operating your target source.

CD player

After pressing CD, you can perform the following operations on the CD player:

► PLAY: Starts playing.
 ◀◀: Returns to the beginning of the current (or previous) track.

▶▶: Skips to the beginning of the next track.
 ■ STOP: Stops playing.

■ PAUSE: Pauses playing. To release it, press ► PLAY.

1 – 10, +10: Selects a track number directly.
 For track number 5, press 5.
 For track number 15, press +10, then 5.
 For track number 20, press +10, then 10.
 For track number 30, press +10, +10, then 10.

CD changer

After selecting “CDDSC” by pressing CONTROL repeatedly, you can perform the following operations on a CD changer:

- ▶ PLAY: Starts playing.
- ◀◀: Returns to the beginning of the current (or previous) track.
- ▶▶: Skips to the beginning of the next track.
- STOP: Stops playing.
- ▬ PAUSE: Pauses playing. To release it, press ▶ PLAY.
- 1 – 6, 7/P: Selects the number of a disc installed in a CD changer.

After pressing CD, you can perform the following operations on the CD changer:

- 1 – 10, +10: Selects a track number directly.
For track number 5, press 5.
For track number 15, press +10, then 5.
For track number 20, press +10, then 10.
For track number 30, press +10, +10, then 10.

EXAMPLE:

- Selecting disc number 4, track number 12, and starting playback.
 1. Press CONTROL repeatedly until “CDDSC” appears on the display window, then press 4.
 2. Press CD, then press +10, 2.

Turntable

After pressing PHONO, you can perform the following operations on a turntable:

- ▶ PLAY: Starts playing.
- STOP: Stops operations.

CD recorder

After pressing CDR (or selecting “CDR” by pressing CONTROL repeatedly), you can perform the following operations on a CD recorder:

- ▶ PLAY: Starts playing.
- ◀◀: Returns to the beginning of the current (or previous) track.
- ▶▶: Skips to the beginning of the next track.
- STOP: Stops playing.
- ▬ PAUSE: Pauses playing. To release it, press ▶ PLAY.
- 1 – 10, +10: Selects a track number directly.
For track number 5, press 5.
For track number 15, press +10, then 5.
For track number 20, press +10, then 10.
For track number 30, press +10, +10, then 10.

Notes:

- When you start recording on the CD recorder, use the buttons on the CD recorder itself or on the remote control supplied with it.
- You can use either CDR or CONTROL to activate the buttons listed above. If you press CDR, the playing source also changes. On the other hand, if you press CONTROL repeatedly to select “CDR,” the playing source does not change.

Cassette deck

After pressing TAPE/MD (or selecting “TAPE” by pressing CONTROL repeatedly), you can perform the following operations on a cassette deck:

- ▶ PLAY: Starts playing.
- REW: Fast winds the tape from right to left.
- FF: Fast winds the tape from left to right.
- STOP: Stops operations.
- ▬ PAUSE: Pauses playing. To release it, press ▶ PLAY.
- REC PAUSE: Enters recording pause.

Notes:

- You can use either TAPE/MD or CONTROL to activate the buttons listed above. If you press TAPE/MD, the playing source also changes. On the other hand, if you press CONTROL repeatedly to select “TAPE,” the playing source does not change.
- When you use a cassette deck, change the source name connected to TAPE/MD jacks correctly (see page 16).

MD recorder

After pressing TAPE/MD, you can perform the following operations on the MD recorder:

- ▶ PLAY: Starts playing.
- ◀◀: Returns to the beginning of the current (or previous) track.
- ▶▶: Skips to the beginning of the next track.
- STOP: Stops playing.
- ▬ PAUSE: Pauses playing. To release it, press ▶ PLAY.
- REC PAUSE: Enters recording pause.

Note:

When you use an MD recorder, change the source name connected to TAPE/MD jacks correctly (see page 16).

Operating Video Components

IMPORTANT:

To operate JVC's video components using this remote control:

- You need to connect JVC video components through the AV COMPU LINK jacks (see page 47) in addition to the connections using cables with RCA pin plugs (see pages 6 and 7).
- Some JVC VCRs can accept two types of the control signals — remote code "A" and "B." Before using this remote control, make sure that the remote control code of the VCR connected to the VCR 1 jacks is set to code "A."
 - When another JVC VCR is connected to the VCR 2 or VIDEO terminals, set its remote control code to code "B." (This remote control cannot emit the control signals of code "B.")
- When using the remote control:
 - For the DVD player and VCR 1 operations, aim the remote control directly at the remote sensor on each component, not on the receiver.
 - For the TV having the AV COMPU LINK EX or AV COMPU LINK III terminal, aim the remote control directly at the remote sensor on the TV.

VCR 1 (VCR connected to the VCR 1 jacks)

You can always perform the following operations:

VCR 1 $\odot/|$: Turns on or off the VCR 1.

After pressing VCR 1 (or selecting "VCR 1" by pressing CONTROL repeatedly), you can perform the following operations on the VCR 1:

- 1 – 9, 0: Selects the TV channels on the VCR.
- ▶ PLAY: Starts playing.
- REW: Rewinds a tape.
- FF: Fast winds a tape.
- STOP: Stops operations.
- ▬ PAUSE: Pauses playing. To release it, press ▶ PLAY.
- REC PAUSE: Enters recording pause.
- CH +/-: Changes the TV channels on the VCR.

Note:

You can use either VCR 1 or CONTROL to activate the buttons listed above. If you press VCR 1, the playing source also changes. On the other hand, if you press CONTROL repeatedly to select "VCR 1," the playing source does not change.

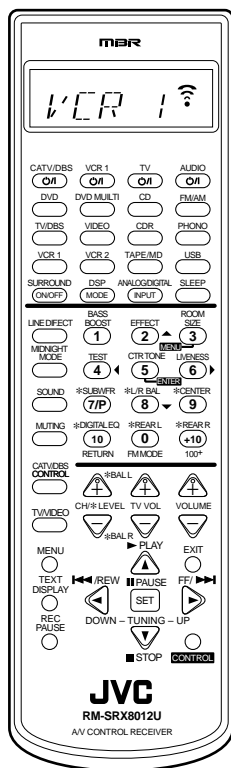

Note:

When you press one of the following buttons mentioned in this section, the operation mode appears on the display window for about 10 seconds. For example, above illustration shows that you have pressed VCR 1.

Buttons	Indications												
VCR 1	VCR 1												
DVD or DVD MULTI	DVD												
TV/DBS	TV												
CONTROL (repeatedly)	<table border="0"> <tr> <td>⌈</td> <td>VCR 1</td> <td>→</td> <td>TAPE</td> </tr> <tr> <td></td> <td>CDDSC</td> <td>←</td> <td>CDR</td> </tr> <tr> <td></td> <td></td> <td></td> <td>⌋</td> </tr> </table>	⌈	VCR 1	→	TAPE		CDDSC	←	CDR				⌋
⌈	VCR 1	→	TAPE										
	CDDSC	←	CDR										
			⌋										

DVD player

After pressing DVD or DVD MULTI, you can perform the following operations on a DVD player:

- ▶ PLAY: Starts playing.
- ⏮: Returns to the beginning of the current (or previous) track.
- ▶▶: Skips to the beginning of the next track.
- STOP: Stops playing.
- ▬ PAUSE: Stops playing temporarily. To release it, press ▶ PLAY.

After pressing DVD or DVD MULTI, these buttons can be used for the DVD menu operations.

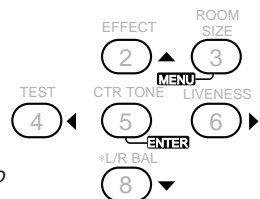

Note:

For detailed menu operations, refer to the instructions supplied with the discs or the DVD player.

TV

You can always perform the following operations:

- TV $\odot/|$: Turns on or off the TV.
- TV VOL +/-: Adjusts the volume.
- TV/VIDEO: Sets the input mode (either TV or VIDEO).

After pressing TV/DBS, you can perform the following operations on a TV:

- CH +/-: Changes the channels.
- 1 – 9, 0, 100+: Selects the channels.
- RETURN: Alternates between the previously selected channel and the current channel.

This remote control supplied with the receiver can transmit control signals for other manufacturers' VCRs, TVs, CATV converters, DBS tuners and DVD players. By changing the transmittable signals from preset ones to the other manufacturers', you can operate the other manufacturer's components using this remote control.

When operating the other manufacturers' components, refer also to the manuals supplied with them. To operate these components with the remote control, first you need to set the manufacturer's code each for VCR, TV, CATV converters, DBS tuners and DVD players.

After replacing batteries for the remote control, you need to set the manufactures' codes again.

To change the transmittable signals for operating another manufacturer's TV

1. Press and hold TV .
2. Press TV/DBS.
3. Enter manufacturer's code using buttons 1-9, and 0.

See the list below to find the code.

4. Release TV .

The following buttons can be used for operating the TV:

TV 	Turns on and off the TV.
TV VOL +/-	Adjusts the volume.
TV/VIDEO:	Sets the input mode (either TV or VIDEO).

After pressing TV/DBS, you can perform the following operations on a TV:

CH +/-:	Changes the channels.
1 - 10, 0, 100+ (+10):	Selects the channels.
	The 10 button will function as the ENTER button if your TV requires pressing ENTER after selecting a channel number.

Note:

Refer to the manual supplied with your TV.

5. Try to operate your TV by pressing TV .

When your TV turns on or off, you have entered the correct code.

If there are more than one code listed for your brand of TV, try each one until the correct one is entered.

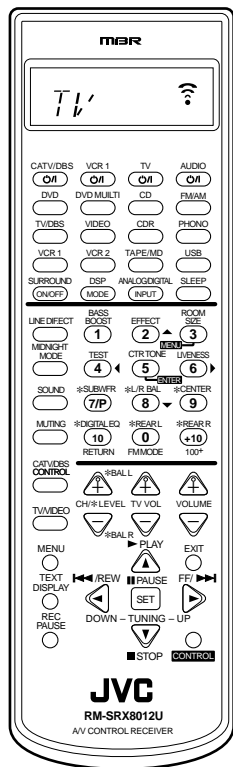

Note:

When you press one of the following buttons mentioned in this section, the operation mode appears on the display window for about 10 seconds. For example, the above illustration shows that you have pressed TV/DBS.

Buttons	Indications
TV/DBS	TV
CATV/DBS CONTROL	DBS
VCR 1	VCR 1
DVD or DVD MULTI	DVD

Manufacturer	Codes	Manufacturer	Codes
JVC	00, 02, 13, 14, 47, 74	QUELLE	52, 53, 54, 55, 56, 57, 58, 59, 60, 61, 62, 63, 64, 65, 66, 67
AKAI	01, 02		
BLAUPUNKT	03, 04,		
FISHER	01, 05	RCA/PROSCAN	08, 24, 29, 30, 31, 48
GRUNDIG	03, 06, 07		
HITACHI	08, 09, 10, 49	SABA	32, 33, 68, 69, 70
IRADDIO	02		
ITT/NOKIA	11, 12	SAMSUNG	06, 08, 16, 34, 35, 49
LOEWE	06, 15, 16		
MAGNAVOX	08, 17, 49	SANYO	01, 05
METS	50, 51, 52, 53	SCHNEIDER	02, 15, 36
MITSUBISHI	08, 18, 19, 20	SHARP	37, 38, 77
MIVAR	21	SONY	39
NORDMENDE	22, 23	TELEFUNKEN	40, 41, 42, 69
OKANO	15	THOMSON	71, 72
PANASONIC	24, 25, 26, 27, 76	TOSHIBA	37, 43, 44
		ZENITH	45, 46
PHILIPS	15, 17, 28, 75		

Manufacturers' codes are subject to change without notice. If they are changed, this remote control cannot operate the equipment.

To change the transmittable signals for operating a CATV converter or DBS tuner

1. Press and hold CATV/DBS $\odot/|$.
2. Press CATV/DBS CONTROL.
3. Enter manufacturer's code using buttons 1–9, and 0.

See the following lists to find the code.

4. Release CATV/DBS $\odot/|$.

The following buttons can be used for the CATV converter and DBS tuner:

CATV/DBS $\odot/ $:	Turns on and off the CATV converter or DBS tuner.
CH +/-:	Changes the channels.
1 – 10, 0, 100+ (+10):	Selects the channels. The 10 button will function as the ENTER button if your equipment requires pressing ENTER after selecting a channel number.

Note:

Refer to the manual supplied with your CATV converter or DBS tuner.

5. Try to operate your CATV converter or DBS tuner by pressing CATV/DBS $\odot/|$.

When your CATV converter or DBS tuner turns on or off, you have entered the correct code.

If there are more than one code listed for your brand of CATV converter or DBS tuner, try each one until the correct one is entered.

Note:

You cannot use both of the CATV converter and DBS tuner at the same time.

For DBS tuner

Manufacturer	Codes
JVC	56, 57, 67
AMSTRAD	43, 44, 45, 46, 47, 48, 49
BLAUPUNKT	30
EHOSTAR	50, 51, 67
GOLDSTAR	31
GRUNDIG	32, 33
HIRSHMANN	48, 52, 53, 54, 55
INSTRUMENT	68
ITT/NOKIA	34
KATHREIN	52, 58, 59, 60, 61, 62, 63
NEC	35, 36
ORBITECH	48
PHILIPS	37, 38
RCA	65
SAMSUNG	39, 40
SCHWAIGER	61, 64
SIEMENS	41, 42
SONY	66
TECHNISAT	48

Manufacturers' codes are subject to change without notice. If they are changed, this remote control cannot operate the equipment.

For CATV converter

Manufacturer	Codes
GENERAL INSTRUMENT	06, 07, 08, 09, 10, 11, 12, 13, 14, 29
HAMLIN/REGAL	01, 02, 03, 04, 05
JERROLD	06, 07, 08, 09, 10, 11, 12, 13, 14
OAK	15, 16, 17
PANASONIC	18, 19, 20
PIONEER	21, 22
SCIENTIFIC ATLANTA	23, 24, 25
TOCOM	26
ZENITH	27, 28

Manufacturers' codes are subject to change without notice. If they are changed, this remote control cannot operate the equipment.

To change the transmittable signals for operating another manufacturer's VCR

1. Press and hold VCR 1 $\odot/|$.
2. Press VCR 1.
3. Enter manufacturer's code using buttons 1–9, and 0.

See the list on the next page to find the code.

4. Release VCR 1 $\odot/|$.

The following button can be used for operating the VCR:

VCR 1 $\odot/ $:	Turns on and off the VCR.
-------------------	---------------------------

After pressing VCR 1, you can perform the following operations on the VCR:

CH +/-:	Changes the TV channels on the VCR.
1 – 10, 0, 100+ (+10):	Selects the TV channels. The 10 button will function as the ENTER button if your VCR requires pressing ENTER after selecting a channel number.
▶ PLAY:	Starts playback.
REW:	Rewinds a video tape.
FF:	Fast winds a video tape.
■ STOP:	Stops operation.
PAUSE:	Pauses.
REC PAUSE:	Enters recording pause.

Note:

Refer to the manual supplied with your VCR.

5. Try to operate your VCR by pressing VCR 1 $\odot/|$.

When your VCR turns on or off, you have entered the correct code.

If there are more than one code listed for your brand of VCR, try each one until the correct one is entered.

Manufacturer	Codes
JVC	00, 26, 27, 28, 29, 58
AIWA	01, 02
BELL & HOWELL	03
BLAUPUNKT	04, 05
CGM	06, 07
EMERSON	08, 10, 11, 12, 64, 65
FISHER	03, 14, 15, 16, 17
FUNAI	01
GE	18, 19, 20
GOLDSTAR	07
GOODMANS	13, 21
GRUNDIG	06, 22
HITACHI	18, 23, 24, 25, 66
LOEWE	07, 21
MAGNAVOX	04, 19, 24
MITSUBISHI	30, 31, 32, 33, 34, 35
NEC	26, 27
NOKIA	03, 36
NORDMENDE	38
ORION	09
PANASONIC	19, 24, 39, 40
PHILIPS	04, 19, 21, 24, 41, 42
PHONOLA	21
RCA/PROSCAN	04, 18, 19, 23, 24, 43, 44, 45
SABA	38, 46
SAMSUNG	45, 47, 59, 61, 62, 63
SANYO	03, 48, 49
SHARP	37, 50
SIEMENS	03, 51
SONY	52, 53, 54
TELEFUNKEN	55, 60
TOSHIBA	43, 44
ZENITH	56, 57

Manufacturers' codes are subject to change without notice. If they are changed, this remote control cannot operate the equipment.

To change the transmittable signals for operating a DVD player

1. Press and hold **AUDIO** .
2. Press **DVD**.
3. Enter manufacturer's code using buttons 1–9, and 0.

See the following list to find the code.

4. Release **AUDIO** .

After pressing DVD or DVD MULTI, you can perform the following operations on a DVD player:

- ▶ **PLAY:** Starts playing.
- ◀◀: Returns to the beginning of the current (or previous) track.
- ▶▶: Skips to the beginning of the next track.
- **STOP:** Stops playing.
- || **PAUSE:** Stops playing temporarily. To release it, press ▶ **PLAY**.

After pressing DVD, these buttons can be used for the DVD menu operations.

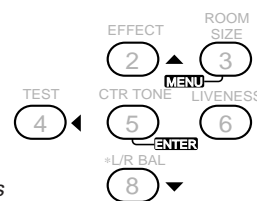

Note:

For detailed menu operations, refer to the instructions supplied with the discs or the DVD player.

Note:

Refer to the manual supplied with your DVD player.

5. Try to operate your DVD player by pressing one of the above buttons.

- DO NOT forget to turn on the DVD player before pressing one of the above buttons.

If there are more than one code listed for your brand of DVD, try each one until the correct one is entered.



Manufacturer	Codes
JVC	00, 02
DENON	01
PANASONIC	03
PHILIPS	13
PIONEER	04, 05, 06
RCA	07
SAMSUNG	08
SONY	09
TOSHIBA	10
YAMAHA	11, 12

Manufacturers' codes are subject to change without notice. If they are changed, this remote control cannot operate the equipment.

Troubleshooting

Use this chart to help you solve daily operational problems. If there is any problem you cannot solve, contact your JVC service center.

PROBLEM	POSSIBLE CAUSE	SOLUTION
The display does not light up.	The power cord is not plugged in.	Plug the power cord into an AC outlet. (See page 10.)
No sound from speakers.	Speaker signal cables are not connected.	Check speaker wiring and reconnect if necessary. (See pages 4 and 5.)
	The SPEAKERS ON/OFF 1 and SPEAKERS ON/OFF 2 buttons are not set correctly.	Press SPEAKERS ON/OFF 1 and SPEAKERS ON/OFF 2 correctly. (See page 13.)
	An incorrect source is selected.	Select the correct source.
	Muting is activated.	Press MUTING to cancel the mute. (See page 13.)
	An incorrect input mode (analog or digital) is selected.	Select the correct input mode (analog or digital). (See page 20.)
Sound from one speaker only.	Connections are incorrect.	Check connections. For analog connections, see page 5. For digital connections, see page 8. For USB connection, see page 9.
	Speaker signal cables are not connected properly.	Check speaker wiring and reconnect if necessary. (See pages 4 and 5.)
No sound from PC connected with a USB cable.	The balance is set to one extreme.	Adjust the balance properly. (See page 16.)
	An electrical shock is applied to the receiver, PC, or USB cable.	Turn off and on the receiver once, then restart the application installed in the PC.
Noise while reproducing PC sound connected with a USB cable.	USB device is not selected on the computer.	Select "USB Audio Device [1]" for "Playback" of "Audio" (see page 9). Refer to the manuals supplied with your PC.
	"Mute" is selected on the PC.	Check if the volume is set at low level. Refer to the manuals supplied with your PC.
Sound from PC connected with a USB cable is intermittent.	Strong electromagnetic wave is emitted from such as television.	Move the PC away from the device such as TV emitting strong electromagnetic wave.
Continuous hiss or buzzing during FM reception.	PC is subjected to excessive load due to using other applications.	Close the applications you do not use.
Occasional cracking noise during FM reception.	Incoming signal is too weak.	Connect an outdoor FM antenna or contact your dealer. (See page 3.)
	The station is too far away.	Select a new station.
	An incorrect antenna is used.	Check with your dealer to be sure you have the correct antenna.
	Antennas are not connected properly.	Check connections. (See page 3.)
Noise is heard.	Ignition noise from automobiles.	Move the antenna farther from automobile traffic.
No sound effect such as DSP mode and digital equalization.	An earth (⏏) cable is not connected to the AM (⏏) terminal on the rear panel.	Connect the cable to the AM (⏏) terminal on the rear panel.
Howling during record playing.	The line direct function is turned on.	Turn off the line direct function. (See page 14.)
	Your turntable is too close to the speakers.	Move the speakers away from the turntable.

PROBLEM	POSSIBLE CAUSE	SOLUTION
“OVERLOAD” starts flashing on the display.	Speakers are overloaded because of high volume.	<ol style="list-style-type: none"> 1. Press STANDBY/ON  on the front panel to turn off the receiver. 2. Stop the playback source. 3. Turn on the receiver again, and adjust the volume.
	Speakers are overloaded because of short circuit of speaker terminals.	<p>Press STANDBY/ON  on the front panel, then check the speaker wiring.</p> <p>If “OVERLOAD” does not disappear, unplug the AC power cord, then plug it back again.</p> <p>If speaker wiring is not short-circuited, contact your dealer.</p>
The STANDBY lamp lights up after turning on the power, but soon the receiver turns off again (into standby mode).	The receiver is overloaded because of a high voltage.	Press STANDBY/ON  on the front panel to turn off the receiver. After unplugging the AC power cord, consult your dealer.
Remote control does not work.	There is an obstruction in front of the remote sensor on the receiver.	Remove the obstruction.
	Batteries are weak.	Replace batteries. (See page 10.)
Remote control does not work intendedly.	An incorrect remote control operation mode is selected.	Select the correct remote control operation mode. (See page 49 – 54.)

Specifications

Amplifier

Output Power:

At Stereo operation:

Front channels: 100 W* per channel, min. RMS, driven into 8 Ω at 1 kHz with no more than 0.8% total harmonic distortion. (IEC268-3/DIN)

At Surround operation:

Front channels: 100 W* per channel, min. RMS, driven into 8 Ω at 1 kHz with no more than 0.8% total harmonic distortion.

Center channel: 100 W*, min. RMS, driven into 8 Ω at 1 kHz, with no more than 0.8% total harmonic distortion.

Rear channels: 100 W* per channel, min. RMS, driven into 8 Ω at 1 kHz, with no more than 0.8% total harmonic distortion.

(*Measured on AC 110 V, 127 V, 220 V and 240 V)

Audio

Audio Input Sensitivity/Impedance (1 kHz): PHONO (MM): 2.5 mV/47 kΩ
 DVD, VCR 1, VCR 2, VIDEO, TV SOUND/DBS, CD, CDR, TAPE/MD: 200 mV/47 kΩ

Audio Input (DIGITAL IN)* : Coaxial: DIGITAL 1 (DVD): 0.5 V(p-p)/75 Ω
 Optical: DIGITAL 2 (CD), DIGITAL 3 (TV), DIGITAL 4 (CDR): -21 dBm to -15 dBm (660 nm ±30 nm)

*Corresponding to Linear PCM, Dolby Digital, and DTS Digital Surround (with sampling frequency — 32 kHz, 44.1 kHz, 48 kHz).

USB: Revision 1.0, full-speed (with sampling frequency — 32 kHz, 44.1 kHz, 48 kHz)

Audio Output Level: VCR 1, VCR 2, CDR, TAPE/MD: 200 mV

Digital output: Optical: DIGITAL OUTPUT: Signal wave length: 660 nm
 Output level: -21 dBm to -15 dBm

Signal-to-Noise Ratio (‘66 IHF/DIN): PHONO (MM): 70 dB/66 dB
 DVD, VCR 1, VCR 2, VIDEO, TV SOUND/DBS, CD, CDR, TAPE/MD: 87 dB/67 dB

Frequency Response (8 Ω): PHONO: 20 Hz to 20 kHz (±1 dB)
 DVD, VCR 1, VCR 2, VIDEO, TV SOUND/DBS, CD, CDR, TAPE/MD: 20 Hz to 100 kHz (+1 dB, -3 dB)
 USB: 20 Hz to 20 kHz (+1 dB, -3 dB)

RIAA Phono Equalization: ±1.0 dB (20 Hz to 20 kHz)

Bass boost: +6 dB ±1.0 dB at 100 Hz

Video

Video Input Sensitivity/Impedance:
 Composite video: DVD, VCR 1, VCR 2, VIDEO, TV SOUND/DBS: 1 V(p-p)/75 Ω
 S-video: DVD, VCR 1, VCR 2, VIDEO, TV SOUND/DBS:
 (Y: luminance): 1 V(p-p)/75 Ω
 (C: chrominance, burst): 0.286 V(p-p)/75 Ω
 Component video: DVD, DBS:
 (Y: luminance): 1 V(p-p)/75 Ω
 (PB, PR): 0.7 V(p-p)/75 Ω

Video Output Level:
 Composite video: VCR 1, VCR 2, MONITOR OUT: 1 V(p-p)/75 Ω
 S-video: VCR 1, VCR 2, MONITOR OUT: (Y: luminance): 1 V(p-p)/75 Ω
 (C: chrominance, burst): 0.286 V(p-p)/75 Ω
 Component video: MONITOR OUT: (Y: luminance): 1 V(p-p)/75 Ω
 (PB, PR): 0.7 V(p-p)/75 Ω

Synchronization: Negative

Signal-to-Noise Ratio: 45 dB

On-Screen Color System: NTSC

FM tuner (IHF)

Tuning Range:	87.50 MHz to 108.00 MHz	
Usable Sensitivity:	Monaural:	12.8 dBf (1.2 μ V/75 Ω)
50 dB Quieting Sensitivity:	Monaural:	21.3 dBf (3.2 μ V/75 Ω)
	Stereo:	41.3 dBf (31.5 μ V/75 Ω)
Signal-to-Noise Ratio (IHF-A weighted):	Monaural:	78 dB at 85 dBf
	Stereo:	73 dB at 85 dBf
Total Harmonic Distortion:	Monaural:	0.4% at 1 kHz
	Stereo:	0.6% at 1 kHz
Stereo Separation at REC OUT:	35 dB at 1 kHz	
Alternate Channel Selectivity:	45 dB: (\pm 400 kHz)	
Frequency Response:	30 Hz to 15 kHz: (+0.5 dB, -3 dB)	

AM tuner

Tuning Range:	531 kHz to 1 602 kHz (at 9 kHz intervals) 530 kHz to 1 600 kHz (at 10 kHz intervals)	
Usable Sensitivity:	Loop antenna	400 μ V/m
Signal-to-Noise Ratio:	50 dB (100 mV/m)	

General

Power Requirements:	AC 110 V/127 V/220 V/230 V – 240V \sim , adjustable with the voltage selector, 50 Hz/60 Hz	
Power Consumption:	210 W (at operation) 2 W (in standby mode)	
Dimensions (W x H x D):	435 mm x 156.5 mm x 425 mm (17 ³ / ₁₆ in. x 6 ³ / ₁₆ in. x 16 ³ / ₄ in.)	
Mass:	11.5 kg (25.4 lbs)	

Designs & specifications are subject to change without notice.

Mains (AC) Line Instruction (not applicable for Europe, U.S.A., Canada, Australia and U.K.)

Instrucción sobre la línea de la red (CA) (no aplicable para Europa, EE.UU., Canadá, Australia, ni el Reino Unido)

Instrução sobre a tensão da rede eléctrica (CA) (não aplicável para a Europa, os E.U.A., o Canadá, a Austrália e o Reino Unido)

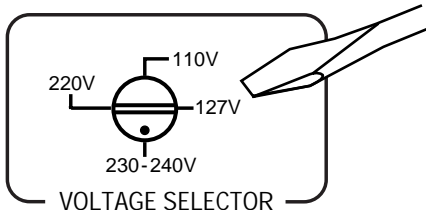
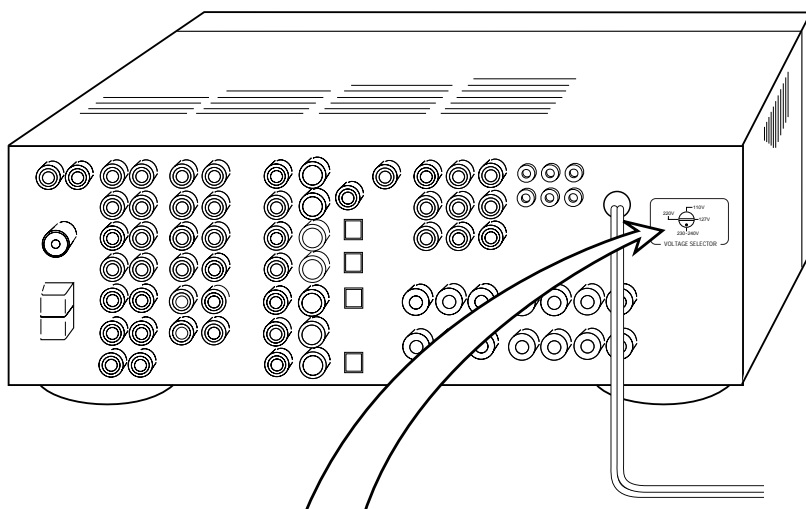

CAUTION for mains (AC) line

BEFORE PLUGGING IN, do check that your mains (AC) line voltage corresponds with the position of the voltage selector switch provided on the outside of this equipment and, if different, reset the voltage selector switch, to prevent from a damage or risk of fire/electric shock.

PRECAUCIÓN para la línea de la red (CA)

ANTES DE ENCHUFAR EL EQUIPO, compruebe si la tensión de la línea de la red (CA) corresponde con la posición del selector de tensión situado en la parte exterior del equipo, y si es diferente, reajuste el selector de tensión para evitar el riesgo de incendios/ descargas eléctricas.

PRECAUÇÃO para a ligação à tensão da rede (CA)

ANTES DE LIGAR O APARELHO A UMA TOMADA DA REDE, verifique se a tensão da rede CA corresponde à posição do selector de tensão localizado na parte externa deste equipamento. Caso não corresponda, reajuste o selector de tensão a fim de evitar avarias ou riscos de incêndio e choque eléctrico.

JVC

VICTOR COMPANY OF JAPAN, LIMITED